



EN | DE | FR | ES | IT | PT

Material Handler | F-Series

MHL 340



129 kW (Diesel, EU-Stage V)
128 kW (Diesel, EU-Stage IIIA)
110 kW (Electric)



28,4–30,6 t



max. 13,7 m











FUCHS[®]

A TEREX BRAND

MHL340 F



	KEY	LEGENDE	LÉGENDE	LEJENDA	LEGENDA	LEGENDA
	Reach	Ausladung	Portée	Alcance	Sbraccio	Alcance
	Engine power	Motorleistung	Puissance du moteur	Potencia del motor	Potenza motore	Potência do motor
	Service weight without attachments	Dienstgewicht ohne Anbaugeräte	Poids de service sans équipements	Peso en servicio sin accesorios	Peso operativo senza attrezzi	Peso operacional sem acessórios
	Center of rotation	Drehmitte	Centre de rotation	Centro de rotación	Centro rotante	Centro de rotação
	Height	Höhe	Hauteur	Altura	Altezza	Altura
	Undercarriage	Unterswagen	Châssis	Carro inferior	Carrello	Chassi
	Not supported	Nicht abgestützt	Non stabilisé	No apoyado	Non puntellato	Não apoiado
	4-point supported	4-Punkt abgestützt	Appuyé sur 4 stabilisateurs	Apoyado en 4 puntos	Sostegno a 4 punti	Apoiado em 4 pontos



Important notes regarding the load capacities

The lift capacity values are stated in metric tons (t). The pump pressure is 360 bar. In accordance with ISO 10567, the lift capacity values represents 75 % of the static tipping loads or 87% of the hydraulic lifting force (marked °). On solid and level ground the values apply to a swing range of 360°. The (...) values apply in the longitudinal direction of the undercarriage. The values for "not supported" only apply via the steering axle or the locked oscillating axle. The weights of the attached load hoisting equipment (grab, load hook, etc.) must be deducted from the lift capacity values. The working load of the lifting device must be observed. In accordance with the EN 474-5 for object handling application hose rupture valves on the boom and stick cylinders, an overload warning device and the lift capacity table in the cab are required. The machine has to be supported on a level ground for object handling application.

Consideraciones importantes sobre las cargas

Los valores de carga se indican en toneladas (t). La presión de la bomba es de 360 bar. Según la norma ISO 10567, los valores ascienden al 75 % de la carga de vuelco o al 87 % de la capacidad de elevación hidráulica (marcado en °). En suelos firmes y planos, los valores son válidos para un radio de inclinación de 360°. Los valores (...) son válidos para el sentido longitudinal del carro inferior. Los pesos de los dispositivos de elevación (cuchara, ganchos de carga, etc.) se deducen de los valores de carga. Hay que tener en cuenta la capacidad de carga de los dispositivos de elevación. En cumplimiento de la norma EN 474-5, para ejecutar elevaciones de carga son necesarias válvulas antirrotura de mangueras en el cilindro de elevación y en el balancín, un dispositivo de aviso de sobrecarga y la tabla de capacidad de carga en la cabina. Realizar las elevaciones de carga con la máquina apoyada.

Wichtige Erläuterungen zu den Traglasten

Die Traglastwerte sind in Tonnen (t) angegeben. Der Pumpendruck beträgt 360 bar. Gemäß ISO 10567 betragen die Werte 75 % der statischen Kippplast oder 87 % der hydraulischen Hubkraft (gekennzeichnet mit °). Auf festem und ebenem Untergrund gelten die Werte für einen Drehbereich von 360°. Die (...) -Werte gelten in Längsrichtung des Unterwagens. Gewichte angebaute Lastaufnahmemittel (Greifer, Lasthaken, usw.) sind von den Traglastwerten abzuziehen. Die zulässige Traglast des Lastaufnahmemittels ist zu beachten. Für den Hebezeugbetrieb sind entsprechend der Norm EN 474-5 Rohrbruchventile an den Hub- und Stielzylindern, eine Überlastwarneinrichtung und die Traglasttabelle in der Kabine erforderlich. Den Hebezeugbetrieb nur mit der eben abgestützten Maschine durchführen.

Spiegazioni importanti sui carichi massimi

I valori dei carichi massimi sono indicati in tonnellate (t). La pressione della pompa è di 360 bar. Conformemente alla norma ISO 10567, questi valori corrispondono al 75 % del carico di ribaltamento statico oppure all'87 % della forza di sollevamento idraulica (contrassegnati con °). Su una superficie di terreno stabile e piana, i valori valgono per un'area di rotazione di 360°. I valori indicati in parentesi (...) si intendono in direzione longitudinale del carrello. I carichi indicati sono applicati al gancio senza attrezzature (benna mordente, gancio di carico ecc.). Il peso dell'attrezzatura va detratto dai valori dei carichi massimi ammessi. La capacità di carico massima ammissibile per la macchina deve essere rispettata. Per l'impiego come apparecchio di sollevamento, conformemente alla norma EN 474-5 è necessario prevedere valvole di arresto automatico sui cilindri di sollevamento e sui cilindri dell'avambraccio, mentre la cabina deve essere provvista di dispositivo di allarme per sovraccarico e tabella dei carichi. Le operazioni di sollevamento devono svolgersi solo a macchina stabilizzata.

Précisions importantes sur les charges

Les charges sont indiquées en tonnes (t). La pression de la pompe est de 360 bar. Conformément à la norme ISO 10567, ces valeurs correspondent à 75 % de la charge statique de basculement ou à 87 % de la force de levage hydraulique (signalées par °). Ces valeurs sont valables pour une plage de rotation de 360° sur un sol ferme et de niveau. Les valeurs entre parenthèses (...) sont valables dans le sens longitudinal du châssis. Le poids des accessoires de levage fixés (grappin, crochet, etc.) doit être soustrait des valeurs de charges admissibles. La charge admissible du moyen de charge doit être observée. Pour le mode levage, il est obligatoire d'avoir des clapets de sécurité sur les vérins de levage et de balancier, ainsi qu'un avertisseur de surcharge et le tableau des charges dans la cabine, conformément à la norme EN 474-5. Le mode levage ne doit être utilisé qu'avec la machine étayée sur un sol de niveau.

Explicações importantes sobre as capacidades de carga

Os valores de capacidade de carga são indicados em toneladas (t). A pressão da bomba é de 360 bar. Segundo a norma ISO 10567, os valores perfazem 75 % da carga basculante estática ou 87% da força de elevação hidráulica (identificados por °). Em superfícies fixas e niveladas, aplicam-se os valores para uma área de oscilação de 360°. Os valores (...) aplicam-se no sentido longitudinal do chassi. Os pesos dos equipamentos de elevação montados (garra, gancho de suspensão, etc) devem ser calculados com base nos valores da capacidade de carga. É necessário ter em conta a capacidade de carga admissível do equipamento de elevação. Para o guincho, são necessárias, de acordo com a norma EN 474-5, válvulas anti-ruptura de tubagens no macaco hidráulico e nos cilindros da haste, um dispositivo de aviso de sobrecarga e a tabela de capacidade de carga na cabina. Executar o guincho somente com a máquina assente em uma superfície nivelada.

		6 m	7,5 m	9 m
10,5 m		(5,2)		
		5,6° (5,6°)		
		5,6° (5,6°)		
9 m		(5,3)	(3,6)	
		6,3° (6,3°)	5,6° (5,6°)	
		6,3° (6,3°)	4,7 (5,6°)	
7,5 m		(5,2)	(3,7)	(2,7)
		6,3° (6,3°)	5,7° (5,7°)	4,2 (4,9°)
		6,3° (6,3°)	4,7 (5,7°)	3,5 (4,9°)

TECHNICAL DATA

OPERATING WEIGHT WITHOUT ATTACHMENTS

MHL340 F	28.4 t–30.6 t
MHL340 F FQC	28.6–29.8 t

DIESEL ENGINE

	EU-Stage V	EU-Stage IIIA / EPA-Tier 3
Manufacturer and model	Deutz 6.1 L6	Deutz TCD2012 L06 2V
Design	6-cylinder inline	6-cylinder inline
Functionality	4-cycle diesel, common rail direct injection, turbocharged with inter-cooler, controlled exhaust gas recirculation, diesel particulate filter with continuous regeneration and SCR catalytic converter	4-cycle diesel, common rail direct injection, turbocharged with intercooler
Engine power	129 kW	128 kW
Rated speed	2000 rpm	2000 rpm
Displacement	6.1 l	6.1 l
Cooling system	Water and charge air cooling with temperature controlled fan speed	Water and charge air cooling with temperature controlled fan speed
Exhaust emission standard	EU-Stage V	EU-Stage IIIA / EPA-Tier 3
Fuel tank	337 l Diesel	337 l Diesel
DEF / Urea tank	32 l AdBlue	■

ELECTRIC MOTOR

Power	110 kW
Total connected load	143 kW
Motor start	Via soft start
Optional cable reel	Up to 50 metres (other lengths on request)

ELECTRICAL SYSTEM

Alternator	28 V / 100 A
Operating voltage	24 V
Battery	2 × 12 V / 110 Ah / 750 A (in accordance with EN standards)
Lighting set	2 × LED headlamps, turn indicators and tail lights
Optional equipment	13 kW or 17 kW DC generator with controls and insulation monitoring

TRAVEL DRIVE

Hydrostatic travel drive via infinitely variable axial piston motor with directly mounted travel brake valve, two-speed manual gearshift, 4-wheel drive

Travel speed 1st gear	5 kph
Travel speed 2nd gear	18 kph
Gradeability	max. 40%
Turning radius	8.3 m

SLEWING DRIVE

Slewing ring	Internally geared, double-row ball turning ring
Drive	2-stage planetary gear with integrated multi-disc brake
Uppercarriage swing speed	0–7.5 rpm variable
Slewing lock	Electrically operated

UNDERCARRIAGE

Front axle	Rigid axle with integral drum brake, planetary drive, max. steering angle: 27°
Rear axle	Oscillating axle with integral drum brake and selectable oscillation lock, planetary drive
Outrigger	4-point stabilizer system
Tires	10.00–20 solid rubber with intermediate rings for MHL340F, 12.00–20 for MHL340F FQC

BRAKE SYSTEM

Service brake	Hydraulic single-circuit braking system acting on all four wheel pairs
Parking brake	Electrically operated disc brake on travel gearbox, acting on both front and rear axles

HYDRAULIC SYSTEM

Pump delivery rate	max. 2 × 330 lpm
Operating pressure	max. 320 / 360 bar
Hydraulic oil tank	372 l

OPERATOR CAB

Cab	Infinitely variable hydraulic height-adjustment with eye level up to 5.60 m above ground. Sound-deadened, ample thermal panoramic glass windows, windshield with pulldown sunblind, viewing window on cab roof, sliding window in cab door, sliding door						
Climate control	Automatic air-conditioning. Infinitely variable heating with 8-speed fan, 10 adjustable air nozzles, including 4 in the roof lining, 3 defroster nozzles						
Operator's seat	Air-sprung comfort seat with integrated headrest, safety belt, and lower lumbar support, optional seat heating. Allows comfortable working by offering universal adjustment possibilities of the seat position, the seat incline, and the position of the seat cushion in relation to the armrests and joysticks						
Monitoring	Ergonomic layout, anti-glare instrumentation. Multifunction display, automatic monitoring and recording of abnormal operating conditions (including all hydraulic oil filters, hydraulic oil temperature (cold/hot), coolant temperature and charge air temperature), diesel particulate filter load, visual and audible warning indication with shutdown of pilot controls/engine power reduction. Diagnosis of individual sensors possible via the multifunction display. Rear view camera and side view camera						
	<table border="1"> <thead> <tr> <th></th> <th>EU-Stage V</th> <th>EU-Stage IIIA / EPA-Tier 3</th> </tr> </thead> <tbody> <tr> <td>Noise level</td> <td>Sound power level (ambience) L_{WA} 99.3 dB(A) (metered) acc. to directive 2000/14/EG L_{WA} 101 dB(A) (guaranteed) acc. to directive 2000/14/EG Sound pressure level (inside the cabin) acc. to standard ISO 6396 L_{PA} 70 dB(A)</td> <td>Sound power level (ambience) L_{WA} 101.7 dB(A) (metered) acc. to directive 2000/14/EG L_{WA} 102 dB(A) (guaranteed) acc. to directive 2000/14/EG Sound pressure level (inside the cabin) acc. to standard ISO 6396 L_{PA} 70 dB(A)</td> </tr> </tbody> </table>		EU-Stage V	EU-Stage IIIA / EPA-Tier 3	Noise level	Sound power level (ambience) L _{WA} 99.3 dB(A) (metered) acc. to directive 2000/14/EG L _{WA} 101 dB(A) (guaranteed) acc. to directive 2000/14/EG Sound pressure level (inside the cabin) acc. to standard ISO 6396 L _{PA} 70 dB(A)	Sound power level (ambience) L _{WA} 101.7 dB(A) (metered) acc. to directive 2000/14/EG L _{WA} 102 dB(A) (guaranteed) acc. to directive 2000/14/EG Sound pressure level (inside the cabin) acc. to standard ISO 6396 L _{PA} 70 dB(A)
	EU-Stage V	EU-Stage IIIA / EPA-Tier 3					
Noise level	Sound power level (ambience) L _{WA} 99.3 dB(A) (metered) acc. to directive 2000/14/EG L _{WA} 101 dB(A) (guaranteed) acc. to directive 2000/14/EG Sound pressure level (inside the cabin) acc. to standard ISO 6396 L _{PA} 70 dB(A)	Sound power level (ambience) L _{WA} 101.7 dB(A) (metered) acc. to directive 2000/14/EG L _{WA} 102 dB(A) (guaranteed) acc. to directive 2000/14/EG Sound pressure level (inside the cabin) acc. to standard ISO 6396 L _{PA} 70 dB(A)					

Certified in accordance with CE regulations

TECHNISCHE DATEN

DIENSTGEWICHT OHNE ANBAUGERÄT

MHL340 F	28,4–30,6 t
MHL340 F FQC	28,6–29,8 t

DIESELMOTOR

	EU-Stufe V	EU-Stufe IIIA / EPA-Tier 3
Hersteller und Typ	Deutz TCD 6.1 L6	Deutz TCD2012 L06 2V
Bauart	6-Zylinder-Reihenmotor	6-Zylinder-Reihenmotor
Funktionsweise	4-Takt-Diesel, Common-Rail-Direkteinspritzung, Turbolader mit Ladeluftkühlung, geregelte Abgasrückführung, Dieselpartikelfilter mit kontinuierlicher Regeneration und SCR-Katalysator	4-Takt-Diesel, Common-Rail-Direkteinspritzung, Turbolader mit Ladeluftkühlung
Motorleistung	129 kW	128 kW
Nenn Drehzahl	2000 min ⁻¹	2000 min ⁻¹
Hubraum	6,1 l	6,1 l
Kühlsystem	Wasser- / Ladeluftkühlung mit temperaturgeregelter Lüfterdrehzahl	Wasser- / Ladeluftkühlung mit temperaturgeregelter Lüfterdrehzahl
Abgasnorm	EU-Stufe V	EU-Stufe IIIA / EPA-Tier 3
Kraftstofftank	337 l Diesel	337 l Diesel
Urea Tank	32 l Ad Blue	■

ELEKTROMOTOR

Leistung	110 kW
Gesamt-Anschlussleistung	143 kW
Motoranlauf	Über Sanftstart
Optional Kabeltrommel	Bis 50 Meter (weitere Längen auf Anfrage)

ELEKTRISCHE ANLAGE

Lichtmaschine	28 V / 100 A
Betriebsspannung	24 V
Batterie	2 × 12 V / 110 Ah / 750 A (nach EN)
Beleuchtungsanlage	2 × LED-Scheinwerfer an der Maschinenfront, Heckbegrenzungs- und Blinkerleuchten
Option	13 kW oder 17 kW Gleichstromgenerator mit Steuerung und Isolationsüberwachung

FAHRANTRIEB

Hydrostatischer Fahrtrieb über stufenlos geregelten Axialkolbenmotor mit direkt angebaute Fahrbremsventil, 2-Gang-Schaltgetriebe, Allradantrieb

Fahrgeschwindigkeit 1. Gang	max. 5 km/h
Fahrgeschwindigkeit 2. Gang	max. 18 km/h
Steigfähigkeit	max. 40 %
Wenderadius	8,3 m

SCHWENKANTRIEB

Drehkranz	Innenverzahnter, doppelreihiger Kugeldrehkranz
Antrieb	2-stufiges Planetengetriebe mit integrierter Lamellenbremse
Oberwagendrehzahl	0–7,5 min ⁻¹ stufenlos
Schwenkretterung	Elektrisch betätigt

UNTERWAGEN

Vorderachse	Planetentriebachse mit integrierter Trommelbremse, starr gelagert, max. Lenkeinschlag 27°
Hinterachse	Planetentriebachse mit integrierter Trommelbremse, pendelnd gelagert mit zuschaltbarer Pendelblockierung
Abstützung	4-Punkt-Abstützung
Bereifung	Vollgummibereifung mit Zwischenringen, 10.00–20 für MHL340F, 12.00–20 für MHL340 F FQC

BREMSEN

Betriebsbremse	Hydraulisch betätigtes Einkreisbremssystem auf alle vier Radpaare wirkend
Feststellbremse	Elektrisch betätigte Scheibenbremse am Fahrtrieb auf beide Achsen wirkend

HYDRAULISCHE ANLAGE

Max. Fördermengen	2 × 330 l/min
Max. Arbeitsdruck	320 / 360 bar
Hydrauliköltank	372 l

FAHRERKABINE

Kabine	Hydraulisch stufenlos hochfahrbar bis auf eine Sichthöhe von 5,60 m Schalldämmung, wärmeschutzverglaste Panoramafenster für beste Rundumsicht, Frontscheibe mit Rolljalousie, Sichtfenster im Kabinendach, Schiebefenster in Kabinentür, Schiebetür	
Klimatisierung	Klimautomatik, Warmwasserheizung mit stufenloser Temperatureinstellung und 8-stufigem Gebläse, 10 einstellbare Luftdüsen, davon 4 im Dachhimmel, 3 Defrosterdüsen	
Fahrersitz	Luftfederter Komfortsitz mit integrierter Kopfstütze, Sicherheitsgurt und Lendenwirbelstütze, auf Wunsch Sitzheizung. Ermöglicht ein ermüdungsfreies Arbeiten durch universelle Verstellmöglichkeiten der Sitzposition, der Sitzneigung sowie der Anordnung des Sitzpolsters zu den Armstützen und den mitschwingenden Joysticks	
Überwachung	Ergonomisch angeordnete, blendfreie Instrumentierung, Multifunktionsdisplay, automatische Überwachung und Speicherung von abweichenden Betriebszuständen (z.B. alle HydraulikölfILTER, Hydrauliköltemperatur kalt/heiß, Kühlflüssigkeittemperatur und Ladelufttemperatur, Beladung Dieselpartikelfilter), optische und akustische Warnung bis zur Abschaltung der Vorsteuerung bzw. Motorleistungsreduzierung. Diagnosemöglichkeit der einzelnen Sensoren über das Multifunktionsdisplay, Rückfahrkamera und Seitenkamera	
	EU-Stufe V	EU-Stufe IIIA / EPA-Tier 3
Schallpegel	Schallleistungspegel (Außenbereich) L _{WA} 99,3 dB(A) (gemessen) nach Richtlinie 2000/14/EG L _{WA} 101 dB(A) (garantiert) nach Richtlinie 2000/14/EG Schallleistungspegel (im Inneren der Kabine) nach Norm ISO 6396 L _{PA} 70 dB(A)	Schallleistungspegel (Außenbereich) L _{WA} 101,7 dB(A) (gemessen) nach Richtlinie 2000/14/EG L _{WA} 102 dB(A) (garantiert) nach Richtlinie 2000/14/EG Schallleistungspegel (im Inneren der Kabine) nach Norm ISO 6396 L _{PA} 70 dB(A)

Zertifizierung nach CE-Richtlinien

Freiwillige DGUV Baumusterprüfung

CARACTÉRISTIQUES TECHNIQUES

POIDS DE SERVICE SANS ÉQUIPEMENT

MHL340 F	28,4–30,6 t
MHL340 F FQC	28,6–29,8 t

MOTEUR DIESEL

	UE-niveau V	UE-niveau IIIA / EPA-Tier 3
Fabricant et type	Deutz TCD 6.1 L6	Deutz TCD2012 L06 2V
Principe	Moteur à 6 cylindres en ligne	Moteur à 6 cylindres en ligne
Principe de travail	Moteur thermique 4 temps, injection directe « common rail », turbocompresseur avec échangeur air/air, recyclage des gaz d'échappement réglé, filtre à particule diesel avec régénération continue et catalyseur RCS	Moteur thermique 4 temps, injection directe « common rail », turbocompresseur avec échangeur air/air
Puissance du moteur	129 kW	128 kW
Régime nominal	2000 min ⁻¹	2000 min ⁻¹
Cylindrée	6,1 l	6,1 l
Système de refroidissement	Refroidissement à eau et échangeur air/air, vitesse du ventilateur à température contrôlée	Refroidissement à eau et échangeur air/air, vitesse du ventilateur à température contrôlée
Norme sur les gaz d'échappement	UE-niveau V	UE-niveau IIIA / EPA-Tier 3
Réservoir à carburant	Diesel 337 l	Diesel 337 l
Réservoir Ad Blue	32 l Ad Blue	■

MOTEUR ÉLECTRIQUE

Puissance	110 kW
Puissance de raccordement totale	143 kW
Démarrage du moteur	Par démarrage progressif
Enrouleur de câble en option	Jusqu'à 50 mètres (autres longueurs sur demande)

CIRCUIT ÉLECTRIQUE

Alternateur	28 V / 100 A
Tension de service	24 V
Batterie	2 x 12 V / 110 Ah / 750 A (selon EN)
Installation d'éclairage	2 x phares LED à l'avant de la machine, feux d'encombrement arrière et clignotants
Option	Génératrice de courant continu 13 kW ou 17 kW avec commande et surveillance d'isolation

ENTRAÎNEMENT

Entraînement hydrostatique par moteur à pistons axiaux à réglage continu, valve de freinage à montage direct, boîte transfert à deux vitesses, transmission intégrale	
Vitesse de conduite 1^{re} vitesse	max. 5 km/h
Vitesse de conduite 2^e vitesse	max. 18 km/h
Aptitude en côtes	max. 40 %
Rayon de braquage	8,3 m

MÉCANISME DE ROTATION

Couronne de rotation	Couronne d'orientation à billes, à double rangée et denture intérieure
Entraînement	Engrenage planétaire à deux étages avec frein à lamelles intégré
Vitesse de rotation tourelle	0–7,5 min ⁻¹ en continu
Blocage de rotation	À commande électrique

CHÂSSIS

Essieu AV	Essieu planétaire, rigide, avec frein à tambour intégré, braquage max. des roues 27°
Essieu AR	Essieu planétaire, oscillant, avec frein à tambour intégré, verrouillage par interrupteur
Appui	4 stabilisateurs
Pneumatiques	Bandage plein à bagues intermédiaires, 10.00–20 pour MHL340F, 12.00–20 pour MHL340 F FQC

FREINS

Frein de service	Système de freinage monocircuit à commande hydraulique agissant sur les quatre paires de roues
Frein de stationnement	Frein à disques accumulé à commande électrique sur la boîte de vitesses agissant sur les deux essieux

INSTALLATION HYDRAULIQUE

Débit max.	2 x 330 l/min
Pression de travail max.	320 / 360 bars
Réservoir d'huile hydraulique	372 l

CABINE

Cabine	Démarrable hydrauliquement en continu jusqu'à une hauteur de vue de 5,60 m. Fenêtre panoramique insonorisée à verre calorifuge pour une meilleure vue panoramique, pare-brise avec pare-soleil roulant, fenêtre avec toit de cabine, vitre coulissante dans la porte de la cabine, porte coulissante
Climatisation	Climatisation automatique. Chauffage à eau chaude avec réglage continu de la température et ventilation à 8 niveaux, 10 diffuseurs d'air réglables, dont 4 dans le pavillon, 3 dégivreurs
Siège conducteur	Siège confort à suspension pneumatique avec appui-tête intégré, sangle de sécurité et support orthopédique des vertèbres lombaires, siège chauffant (en option). Grâce aux possibilités universelles de réglage (position et inclinaison du siège, disposition du rembourrage par rapport aux accoudoirs et joysticks résonants), le siège garantit l'absence de fatigue physique pendant le travail
Surveillance	Disposition ergonomique de l'instrumentation antireflets, écran multifonction, surveillance et enregistrement automatiques des états de fonctionnement irréguliers (par ex. tous les filtres hydrauliques, température d'huile hydraulique froid/chaud, température de réfrigérant et température d'air de suralimentation, chargement du filtre à particule diesel), avertissement visuel et sonore jusqu'à l'arrêt de la commande pilote ou de la réduction de puissance du moteur. Moyen de diagnostic des différents capteurs par l'intermédiaire de l'affichage multifonctions, la caméra de recul et la caméra latérale

	UE-niveau V	UE-niveau IIIA / EPA-Tier 3
Niveaux sonores	Puissance acoustique (extérieur) L _{WA} 99,3 dB(A) (mesuré) selon la directive 2000/14/CE L _{WA} 101 dB(A) (garanti) selon la directive 2000/14/CE	Puissance acoustique (extérieur) L _{WA} 101,7 dB(A) (mesuré) selon la directive 2000/14/CE L _{WA} 102 dB(A) (garanti) selon la directive 2000/14/CE
	Puissance acoustique (à l'intérieur de la cabine) selon la directive ISO 6396 L _{PA} 70 dB(A)	Puissance acoustique (à l'intérieur de la cabine) selon la directive ISO 6396 L _{PA} 70 dB(A)
Certification suivant directives CE		

DATOS TÉCNICOS

PESO EN SERVICIO SIN ACCESORIOS

MHL340 F	28,4–30,6 t
MHL340 F FQC	28,6–29,8 t

MOTOR DIÉSEL

	Etapa Euro V	Etapa Euro IIIA / EPA-Tier 3
Fabricante y tipo	Deutz TCD 6.1 L6	Deutz TCD2012 L06 2V
Tipo de construcción	Motor en línea de 6 cilindros	Motor en línea de 6 cilindros
Procedimientos de trabajo	Diésel de 4 ciclos, inyección directa Common Rail, turbocompresor con refrigerador del aire de admisión, recirculación regulada de los gases de escape, filtro de partículas diésel con regeneración continua y catalizador SCR	Diésel de 4 ciclos, inyección directa Common Rail, turbocompresor con refrigerador del aire de admisión
Potencia del motor	129 kW	128 kW
Velocidad nominal	2000 min ⁻¹	2000 min ⁻¹
Cilindrada	6,1 l	6,1 l
Sistema de refrigeración	Refrigerador de agua / aire de admisión con velocidad del ventilador regulada por la temperatura	Refrigerador de agua / aire de admisión con velocidad del ventilador regulada por la temperatura
Norma de emisiones	Etapa Euro V	Etapa Euro IIIA / EPA-Tier 3
Depósito de combustible	337 l Diésel	337 l Diésel
Depósito de Ad Blue	32 l Ad Blue	■

ELECTROMOTOR

Potencia	110 kW
Potencia conectada total	143 kW
Arranque del motor	Progresivo
Tambor de cable opcional	Hasta 50 metros (más longitudes a petición)

SISTEMA ELÉCTRICO

Alternador	28 V / 100 A
Tensión de funcionamiento	24 V
Batería	2 × 12 V / 110 Ah / 750 A (según EN)
Sistema de iluminación	2 faros LED en el frontal de la máquina, luces de señalización trasera e intermitentes
Opcional	Generador de corriente continua de 13 kW o 17 kW con control y supervisión de aislamiento

ACCIONAMIENTO

Accionamiento hidrostático a través de motor variable de pistones axiales con válvula de freno de servicio montada directamente, caja de cambios de 2 marchas, tracción total

Velocidad de marcha en la 1ª marcha	máx. 5 km/h
Velocidad de marcha en la 2ª marcha	máx. 18 km/h
Capacidad de ascenso	máx. 40 %
Radio de giro	8,3 m

SISTEMA DE GIRO

Corona giratoria	Con dentado interior, corona de rotación de fila doble
Accionamiento	Engranaje planetario de 2 niveles con freno multidisco integrado
Número de revoluciones de la superestructura	0–7,5 min ⁻¹ continuo
Bloqueo de oscilación	De accionamiento eléctrico

CARRO INFERIOR

Eje delantero	Eje planetario, con freno de tambor integrado, fijo, ángulo máx. de viraje 27°
Eje trasero	Accionamiento planetario con freno de tambor integrado, oscilante con bloqueo de oscilación por interruptor
Apoyos	Apoyo de 4 puntos
Neumáticos	Neumáticos de goma maciza con anillos intermedios, 10.00–20 para MHL340F, 12.00–20 para MHL340 F FQC

FRENOS

Freno de servicio	Sistema de freno hidráulico de un solo circuito que actúa en los cuatro pares de ruedas
Freno de estacionamiento	Freno eléctrico de disco en el engranaje de marcha que actúa en ambos ejes

SISTEMA HIDRÁULICO

Caudales máx.	2 × 330 l/min
Presión de trabajo máx.	320 / 360 bar
Depósito de aceite hidráulico	372 l

CABINA DEL CONDUCTOR

Cabina	Elevable por mecanismo hidráulico continuo a un nivel visual de 5,60 m. Insonorizada, ventana panorámica para la máxima visibilidad con acristalamiento antitérmico, parabrisas con persiana, ventana en el techo, ventana corredera en la puerta de la cabina, puerta corredera
Sistema de climatización	Control de climatización automático Calefacción de agua caliente con ajuste de temperatura continuo y 8 niveles de ventilación, 10 boquillas de aire ajustables, de ellas 4 en el techo, 3 boquillas de descongelación
Asiento del conductor	Asiento confortable de suspensión neumática con reposacabezas integrado, cinturón de seguridad y apoyo lumbar, si se desea, calefacción del asiento (opción). Permite trabajar sin cansarse gracias al mecanismo de ajuste universal de la posición del asiento, de la inclinación y de la colocación del acolchado del asiento en relación con los reposabrazos y los joysticks de accionamiento
Vigilancia	Instrumentos colocados de manera ergonómica y antideslumbrantes, pantalla multifunción, vigilancia automática y registro de los estados operativos divergentes (p. ej. todos los filtros de aceite hidráulico, temperatura del aceite hidráulico fría/caliente, temperatura del líquido de refrigeración y temperatura del aire de alimentación), avisos ópticos y acústicos hasta la desconexión de la prealimentación o la reducción del rendimiento del motor. Posibilidad de diagnóstico de cada sensor a través de la pantalla multifunción, de la cámara de marcha atrás y de la cámara lateral

	Etapa Euro V	Etapa Euro IIIA / EPA-Tier 3
Valores del nivel de ruido	Nivel de potencia acústica (exterior) L _{WA} 99,3 dB(A) (medido) según la Directiva 2000/14/CE L _{WA} 101 dB(A) (medido) según la Directiva 2000/14/CE	Nivel de potencia acústica (exterior) L _{WA} 101,7 dB(A) (medido) según la Directiva 2000/14/CE L _{WA} 102 dB(A) (medido) según la Directiva 2000/14/CE
	Nivel de potencia acústica (en el interior de la cabina) según la Directiva ISO 6396 L _{PA} 70 dB(A)	Nivel de potencia acústica (en el interior de la cabina) según la Directiva ISO 6396 L _{PA} 70 dB(A)

Certificación según las directivas de la CE

DATI TECNICI

PESO OPERATIVO SENZA ATTREZZI

MHL340 F	28,4–30,6 t
MHL340 F FQC	28,6–29,8 t

MOTORE DIESEL

	Categoria Euro V	Categoria Euro IIIA / EPA-Tier 3
Marca e modello	Deutz TCD 6.1 L6	Deutz TCD2012 L06 2V
Costruzione	Motore a 6 cilindri in linea	Motore a 6 cilindri in linea
Ciclo di lavoro	Motore diesel a 4 tempi, sistema d'iniezione diretta Common Rail, turbocompressore con intercooler, ritorno gas di scarico variabile, filtro antiparticolato diesel con rigenerazione continua e catalizzatore SCR	Motore diesel a 4 tempi, sistema d'iniezione diretta Common Rail, turbocompressore con intercooler
Potenza motore	129 kW	128 kW
Regime nominale	2000 min ⁻¹	2000 min ⁻¹
Cilindrata	6,1 l	6,1 l
Sistema di raffreddamento	Ad acqua/intercooler con regime del ventilatore termoregolato	Ad acqua/intercooler con regime del ventilatore termoregolato
Normativa sui gas di scarico	Categoria Euro V	Categoria Euro IIIA / EPA-Tier 3
Serbatoio del carburante	337 l diesel	337 l diesel
Serbatoio AdBlue	32 l Ad Blue	■

MOTORE ELETTRICO

Potenza	110 kW
Potenza totale allacciata	143 kW
Avviamento del motore	Tramite soft start
Tamburo avvolgicavi opzionale	Fino a 50 metri (disponibili a richiesta anche altre lunghezze)

CIRCUITO ELETTRICO

Alternatore	28 V/100 A
Tensione di esercizio	24 V
Batteria	2 × 12 V / 110 Ah / 750 A (a norma EN)
Impianto luci	2 × fari LED sulla parte anteriore della macchina, luci d'ingombro posteriori e indicatori di direzione
Opzione	Generatore a corrente continua da 13 kW o 17 kW con controllo e monitoraggio dell'isolamento

TRAZIONE

Trazione idrostatica mediante motore a pistoni assiali a regolazione continua con valvola di rallentamento montata direttamente, cambio a 2 marce, trazione integrale

Velocità di marcia 1° marcia	max. 5 km/h
Velocità di marcia 2° marcia	max. 18 km/h
Capacità di salita	max. 40%
Diametri di sterzata	8,3 m

GRUPPO DI ROTAZIONE

Ralla	Dentatura interna, corona di tornitura sferica a doppia fila
Trasmissione	Ingranaggi planetari a 2 stadi con freno a dischi integrato
Numero di giri della torretta	0-7,5 min ⁻¹ in continuo
Arresto rotazione	Ad azionamento elettrico

CARRELLO

Assale anteriore	Assale motore planetario con freno a tamburo integrato, rigido, angolo di sterzata max. 27°
Assale posteriore	Assale motore planetario con freno a tamburo integrato, oscillante, con possibilità di bloccare l'oscillazione
Sostegno	Sostegno a 4 punti
Pneumatici	Pneumatici a gomma piena con anelli distanziatori, 10.00-20 per MHL340F, 12.00-20 per MHL340 F FQC

FRENI

Freno di servizio	Sistema di frenatura monocircuito ad azionamento idraulico che agisce su tutte e quattro le coppie di ruote.
Freno di stazionamento	Freno a dischi azionato elettricamente dal cambio con azione su entrambi gli assi

IMPIANTO IDRAULICO

Portate max.	2 × 330 l/min
Pressione di lavoro max.	320/360 bar
Serbatoio olio idraulico	372 l

CABINA DI GUIDA

Cabina	Cabina a sollevamento idraulico continuo fino ad un'altezza di 5,60 m Vetri panoramici con isolamento termico-acustico per la massima visuale, parabrezza con avvolgibile, finestra d'ispezione nel tetto della cabina, finestrino scorrevole nella porta della cabina, porta scorrevole
Climatizzazione	Climatizzazione automatica. Riscaldamento ad acqua calda con regolazione continua della temperatura e soffiante a 8 livelli, 10 bocchette di aerazione regolabili, di cui 4 nel tetto, 3 sbrinatori regolabili
Sedile conducente	Sedile comfort a sospensione pneumatica con poggiatesta integrato, cintura di sicurezza e supporto lombare, sedile riscaldato (su richiesta). Riduce l'affaticamento grazie alla possibilità di regolare la posizione o l'inclinazione del sedile nonché grazie alla posizione dell'imbottitura rispetto ai braccioli e joystick risonante
Controllo	Strumentazione disposta in modo ergonomico, antiriflesso, display multifunzione, controllo automatico e memorizzazione delle modalità operative anomale con spie di allarme (ad es. tutti i filtri dell'olio idraulico, temperatura dell'olio idraulico freddo/caldo, temperatura del liquido di raffreddamento e temperatura dell'aria di alimentazione, carico filtro antiparticolato diesel), allarme ottico e acustico fino alla disattivazione del pilotaggio o riduzione della potenza del motore. Possibilità diagnostica dei singoli sensori mediante il display multifunzione, videocamera di retromarcia e videocamera laterale

	Categoria Euro V	Categoria Euro IIIA / EPA-Tier 3
Livelli di pressione acustica	Livello di pressione acustica (all'aperto) L _{WA} 99,3 dB(A) (misurato) secondo la direttiva 2000/14/CE L _{WA} 101 dB(A) (garantito) secondo la direttiva 2000/14/CE	Livello di pressione acustica (all'aperto) L _{WA} 101,7 dB(A) (misurato) secondo la direttiva 2000/14/CE L _{WA} 102 dB(A) (garantito) secondo la direttiva 2000/14/CE
	Livello di pressione acustica (all'interno della cabina) secondo la direttiva ISO 6396 L _{PA} 70 dB(A)	Livello di pressione acustica (all'interno della cabina) secondo la direttiva ISO 6396 L _{PA} 70 dB(A)

Attestazione secondo le direttive CE

DADOS TÉCNICOS

PESO OPERACIONAL SEM ACESSÓRIO

MHL340 F	28,4–30,6 t
MHL340 F FQC	28,6–29,8 t

MOTOR A DIESEL

	Nível V UE	Nível IIIA UE / EPA-Tier 3
Fabricante e tipo	Deutz TCD 6.1 L6	Deutz TCD2012 L06 2V
Modelo	Motor de 6 cilindros em linha	Motor de 6 cilindros em linha
Processo de trabalho	Diesel de 4 tempos, injeção direta Common Rail, turbo-compressor com resfriamento de ar de sobrealimentação, sistema de recirculação dos gases de escape regulado, filtro de partículas de motor a diesel com regeneração contínua e catalisador SCR	Diesel de 4 tempos, injeção direta Common Rail, turbo-compressor com resfriamento de ar de sobrealimentação
Potência do motor	129 kW	128 kW
Rotação nominal	2000 min ⁻¹	2000 min ⁻¹
Cilindrada	6,1 l	6,1 l
Sistema de refrigeração	Refrigeração a água/ar de sobrealimentação com velocidade do ventilador com controle por temperatura	Refrigeração a água/ar de sobrealimentação com velocidade do ventilador com controle por temperatura
Norma relativa aos gases de escape	Nível V UE	Nível IIIA UE / EPA-Tier 3
Depósito de combustível	337 l Diesel	337 l Diesel
Depósito de Ad Blue	32 l Ad Blue	■

MOTOR ELÉTRICO

Potência	110 kW
Potência de ligação total	143 kW
Arranque do motor	Com arranque suave
Tambor de cabos opcional	Até 50 metros (outros comprimentos disponíveis sob pedido)

SISTEMA ELÉTRICO

Gerador	28 V/100 A
Tensão operacional	24 V
Bateria	2 × 12 V / 110 Ah / 750 A (conforme EN)
Sistema de iluminação	2 × faróis LED na frente da máquina, luzes traseiras e luzes de indicação de mudança de direção
Opção	Dínamo de 13 kW ou 17 kW com controle e monitoramento de isolamento

TRANSMISSÃO

Transmissão hidrostática através de um motor de pistão axial de controle progressivo com válvula de freio de serviço montada diretamente, caixa de velocidade de 2 mudanças, tração total

Velocidade da 1ª marcha	máx. 5 km/h
Velocidade da 2ª marcha	máx. 18 km/h
Capacidade de inclinação	máx. 40%
Raio de viragem	8,3 m

SISTEMA GIRATÓRIO

Coroa giratória	Coroa de orientação interna paralela
Acionamento	Engrenagem planetária bifásica com freio de discos múltiplos integrado
Velocidade rotação da estrutura superior	0–7,5 min ⁻¹ progressiva
Bloqueio do sistema de rotação	Acionamento elétrico

CHASSI

Eixo dianteiro	Eixo planetário com freio de tambor integrado, de montagem rígida, ângulo de giro máx. de 27°
Eixo traseiro	Eixo planetário oscilante com freio de tambor integrado, de montagem oscilante e bloqueio de oscilação acionável
Apoio	Apoio em 4 pontos
Rodado	Pneus de borracha maciça com anéis espaçadores, 10.00–20 para MHL340F, 12.00–20 para MHL340 F FQC

SISTEMA DE FRENAGEM

Freio de serviço	Sistema de freio de circuito único de acionamento hidráulico nos quatro pares de rodas
Freio de mão	Freio de disco de acionamento elétrico na caixa de transmissão em ambos os eixos

SISTEMA HIDRÁULICO

Volume máx.	2 × 330 l/min
Pressão de funcionamento máx.	320/360 bar
Depósito de fluido hidráulico	372 l

CABINE DO CONDUTOR

Cabine	Elevação progressiva através do sistema hidráulico até uma altura de visibilidade de 5,60 m Janelas panorâmicas com isolamento de ruído e vidro de proteção térmica para uma melhor visibilidade, para-brisas com estore, janela de visualização no tejadilho, janela deslizante na porta da cabine, porta deslizante
Climatização	Ar condicionado automático. Aquecimento a água quente com ajuste progressivo da temperatura e ventilador de 8 níveis, 10 jatos de ar ajustáveis, dos quais 4 no tejadilho, 3 bocais anticongelamento
Banco do condutor	Banco de conforto com suspensão a ar e encosto para a cabeça integrada, cinto de segurança e apoio lombar, assentos aquecidos (opcional). Permite trabalhar confortavelmente graças a opções de ajuste universais da posição do banco, da inclinação do banco, bem como da posição das almofadas dos apoios de braços e dos joysticks articuláveis

Monitoramento	Painel de instrumentos ergonômico e antibrilho, visor multifunções, monitoramento automático e gravação de estados de funcionamento divergentes (por exemplo, todos os filtros de fluido hidráulico, temperatura do fluido hidráulico frio/quente, temperatura do fluido de refrigeração e temperatura do ar de sobrealimentação, carregamento do filtro de partículas do motor a diesel), aviso ideal e sonoro até a desativação do pré-controle e redução da potência do motor. Possibilidade de diagnóstico dos sensores individuais através do visor multifunções, câmera traseira e câmera lateral
----------------------	---

	Nível V UE	Nível IIIA UE / EPA-Tier 3
Valores do nível sonoro	Nível de potência sonora (exterior) L _{WA} 99,3 dB(A) (medido) conforme a Diretiva 2000/14/CE L _{WA} 101 dB(A) (garantido) conforme a Diretiva 2000/14/CE Nível de pressão sonora (no interior da cabine) conforme a Diretiva ISO 6396 L _{PA} 70 dB(A)	Nível de potência sonora (exterior) L _{WA} 101,7 dB(A) (medido) conforme a Diretiva 2000/14/CE L _{WA} 102 dB(A) (garantido) conforme a Diretiva 2000/14/CE Nível de pressão sonora (no interior da cabine) conforme a Diretiva ISO 6396 L _{PA} 70 dB(A)

Certificação conforme as Diretivas CE

EQUIPMENT	AUSSTATTUNG	EQUIPEMENT	EQUIPO	APPARECCHIATURA	EQUIPAMENTO	Standard Estándar Padrão	Option En option Opzionale Opção
DIESEL ENGINE	DIESELMOTOR	MOTEUR DIESEL	MOTOR DIÉSEL	MOTORE DIESEL	MOTOR A DIESEL		
Intercooler and coolant radiator	Ladeluft- und Wasserkühler	Radiateur d'air de suralimentation et de liquide de refroidissement	Refrigerador de aire de admisión y de líquido refrigerante	Radiatore del refrigerante e di alimentazione	Sistema de refrigeração do ar de sobrealimentação/ líquido de refrigeração	●	
Direct electronic fuel injection / common rail	Elektronische Direkt-einspritzung / Common Rail	Injection directe électronique / Common Rail	Inyección directa electrónica / Common Rail	Iniezione elettrica diretta/ Common Rail	Injeção direta eletrônica/ Common Rail	●	
Advanced automatic idle incl. engine shut-off function	Erweiterte Leerlaufautomatik mit Motorabschaltfunktion	Marche à vide automatique étendue avec fonction d'arrêt du moteur	Ralentí automático avanzado con función de apagado del motor	Minimo automatico avanzato con funzione di spegnimento motore	Sistema automático de ponto morto avançado com função de corte da corrente do motor	●	
Engine preheating	Motorvorwärmung	Préchauffage du moteur	Precalementamiento del motor	Preriscaldamento del motore	Pré-aquecimento do motor		●
Engine diagnostics interface	Motor-Diagnose-Schnittstelle	Interface de diagnostic moteur	Interfaz de diagnóstico del motor	Interfaccia diagnosi motore	Interface de diagnóstico do motor	●	
Temperature-dependent fan drive	Temperatureregelter Lüfterantrieb	Entraînement de ventilateur en fonction de la température	Accionamiento del ventilador en función de la temperatura	Azionamento ventilatore dipendente dalla temperatura	Acionamento do ventilador em função da temperatura	●	
UNDERCARRIAGE	UNTERWAGEN	CHÂSSIS	CARRO INFERIOR	CARRELLO	CHASSI		
All-wheel drive	Allradantrieb	Transmission intégrale	Tracción integral	Trazione integrale	Tração total	●	
Drum brakes	Trommelbremse	Frein à tambour	Freno de tambor	Freni a tamburo	Freio de tambor	●	
Rear axle oscillating lock	Pendelachsverriegelung Hinterachse	Essieu AR oscillant à verrouillage hydraulique	Bloqueo del eje de oscilación eje trasero	Blocco dell'assale oscillante asse posteriore	Bloqueio de oscilação do eixo traseiro	●	
2-speed powershift transmission	2-Gang-Lastschaltgetriebe	Boîte transfert à passage sous charge, à 2 paliers	Caja de cambios de 2 marchas	Trasmissione powershift a 2 velocità	Transmissão de 2 velocidades		●
4-point stabilizers	4-Punkt-Abstützung	4 stabilisateurs	Apoyo de 4 puntos	Sostegno a 4 punti	Apóio em 4 pontos	●	
Dozer blade in addition to 4-point stabilizers	Räumschild zusätzlich zur 4-Punkt-Anstützung	Lame de remblayage en complément aux 4 stabilisateurs	Pala adicional al apoyo de 4 puntos	Lama livellatrice accessoria al sostegno a 4 punti	Lâmina para além do apoio em 4 pontos		●
Stabilizer cylinders with integrated two-way check valves	Abstützylinder mit integrierten beidseitigen Absperrventilen	Vérins d'appui avec robinets d'isolement intégrés sur les deux côtés	Cilindro de apoyo con válvulas de cierre integradas a ambos lados	Cilindro di sostegno con valvole d'intercettazione integrate su entrambi i lati	Cilindros de apoio com válvulas de bloqueio integradas de ambos os lados	●	
Piston rod protection on stabilizer cylinders	Kolbenstangenschutz am Abstützylinder	Tiges des vérins d'appui protégées	Protección del vástago del pistón con cilindro de apoyo	Protezione steli degli stantuffi sul cilindro di sostegno	Proteção da haste do pistão no cilindro de apoio	●	
Tool box	Werkzeugkasten	Caisse à outils	Caja de herramientas	Cassetta attrezzi	Caixa de ferramentas	●	
Special paint (customer paint work)	Sonderlackierung	Peinture spéciale	Pintura especial	Verniciatura speciale	Pintura especial		●
Solid rubber tires (10.00-20) with intermediate rings	Vollgummibereifung 10.00-20 mit Zwischenringen	Bandage plein 10.00-20 à bagues intermédiaires	Neumáticos de goma maciza 10.00-20 con anillos intermedios	Pneumatici a gomma piena 10.00-20 con anelli distanziatori	Pneus de borracha maciça 10.00-20 com anéis espaçadores	●	
Solid rubber tires (12.00-20) with intermediate rings (FQC)	Vollgummibereifung 12.00-20 mit Zwischenringen (FQC)	Bandage plein 12.00-20 à bagues intermédiaires (FQC)	Neumáticos de goma maciza 12.00-20 con anillos intermedios (FQC)	Pneumatici a gomma piena 12.00-20 con anelli distanziatori (FQC)	Pneus de borracha maciça 12.00-20 com anéis espaçadores (FQC)	●	
UPPERCARRIAGE	OBERWAGEN	TOURELLE	SUPERESTRUCTURA	TORRETTA	ESTRUTURA SUPERIOR		
Separate cooling system for engine and hydraulic oil cooler	Getrenntes Kühlsystem für Motor- und Hydrauliköl-Kühler	Système de refroidissement séparé pour radiateur moteur et d'huile hydraulique	Sistema de refrigeración separado para el refrigerador del motor y de aceite hidráulico	Sistema di raffreddamento separato per radiatore motore e olio idraulico	Sistema de refrigeração separado para motor e fluido hidráulico	●	
Cooling system with temperature-dependent fan drive	Kühlsystem mit temperaturabhängigem Lüfterantrieb	Circuit de refroidissement avec entraînement de ventilateur en fonction de la température	Sistema de refrigeración con accionamiento del ventilador en función de la temperatura	Sistema di raffreddamento con azionamento ventilatori dipendente dalla temperatura	Sistema de refrigeração com accionamento do ventilador em função da temperatura	●	
Fan drive reversing function	Umkehrlüfter	Ventilateur réversible	Ventilador reversible	Ventola a inversione	Inversão do ventilador		●
Automatic central lubrication system	Zentralschmieranlage, automatisch	Graissage centralisé, automatique	Dispositivo de lubricación central automático	Impianto di lubrificazione centrale, automatico	Sistema de lubrificação central, automático	●	
Rear view camera	Rückfahrkamera	Caméra de marche arrière	Cámara de marcha atrás	Videocamera per retromarcia	Câmera de marcha à ré	●	
Side view camera	Seitenkamera	Caméra latérale	Cámara lateral	Videocamera laterale	Câmera lateral	●	
Travel alarm	Fahrwarneinrichtung	Dispositif d'avertissement de conduite	Alarma de marcha	Dispositivo di segnalazione marcia	Alarme de deslocamento		●
Electric refuelling pump	Betankungspumpe, elektrisch	Pompe de carburant électrique	Bomba de repostaje eléctrica	Pompa di rifornimento elettrica	Bomba de reabastecimento, elétrica		●
Lighting protection	Leuchtenschutz	Protection des phares	Protección para los faros	Protezione lampade	Proteção da iluminação		●
Special paint (customer paint work)	Sonderlackierung	Peinture spéciale	Pintura especial	Verniciatura speciale	Pintura especial		●
CAB	KABINE	CABINE	CABINA	CABINA	CABINE		
Hydraulically adjustable cab	Kabinensystem hochfahrbar	Système de cabine levable	Sistema de cabina elevable	Sistema di cabina sollevabile	Sistema da cabine com elevação	●	
Safety glass	Sicherheitsverglasung	Vitrage de sécurité	Acrilado de seguridad	Vetri di sicurezza	Vitrificação de segurança	●	
Sliding window in cab door	Schiebefenster in Kabinentür	Vitre coulissante dans la porte de la cabine	Ventana corredera en la puerta de la cabina	Finestrino scorrevole nella porta della cabina	Janela deslizante na porta da cabine	●	
Reinforced glass P5A (windscreen and roof panel)	Verbundsicherheitsglas P5A (Frontscheibe und Dachfenster)	Vitrage blindé P5A (pare-brise et fenêtre de toit)	Cristal blindado P5A (parabrisas y ventana del techo)	Vetro blindato P5A (parabrezza e finestrino tetto)	Vidro blindado P5A (para-brisas e janela do tejadilho)		●
Reinforced glass P5A (windscreen and roof panel) (FQC)	Verbundsicherheitsglas P5A (Frontscheibe und Dachfenster) (FQC)	Vitrage blindé P5A (pare-brise et fenêtre de toit) (FQC)	Cristal blindado P5A (parabrisas y ventana del techo) (FQC)	Vetro blindato P5A (parabrezza e finestrino tetto) (FQC)	Vidro blindado P5A (para-brisas e janela do tejadilho) (FQC)	●	

EQUIPMENT	AUSSTATTUNG	EQUIPEMENT	EQUIPO	APPARECCHIATURA	EQUIPAMENTO	Standard Estandár Padrão	Option En option Opcional Opção
CAB	KABINE	CABINE	CABINA	CABINA	CABINE		
Windshield washer system (windscreen)	Wisch-Waschanlage (Frontscheibe)	Système essuie/lave-glace (pare-brise)	Limpiaparabrisas (parabrisas)	Tergilavavetro (parabrezza)	Sistema de lavagem (para-brisas)	●	
Roof washer system	Wisch-Waschanlage (Dachfenster)	Système essuie/lave-glace (fenêtre de toit)	Limpiaparabrisas (ventana del techo)	Tergilavavetro (finestrino tetto)	Sistema de lavagem (janela do tejadilho)		●
Air-cushioned operator seat with headrest, seatbelt, and lumbar support	Fahrersitz luftgefedert mit Kopfstütze, Sicherheitsgurt und Lendenwirbelstütze	Siège à suspension pneumatique avec appui-tête, ceinture de sécurité et soutien lombaire	Asiento del conductor con suspensión neumática con reposacabezas, cinturón de seguridad y apoyo lumbar	Sedile del conducente molleggiato ad aria con poggiatesta, cintura di sicurezza e supporto lombare	Banco do condutor com suspensão a ar e encosto para a cabeça, cinto de segurança e apoio de segurança	●	
Seat heating	Sitzheizung	Siège chauffant	Calefacción del asiento	Riscaldamento sedile	Aquecimento do banco		●
Joystick steering	Joystick Lenkung	Direction joystick	Dirección con joystick	Sterzata con joystick	Controle por joystick	●	
Steering column, height and tilt adjustable	Lenksäule, neigbar und höhenverstellbar	Colonne de direction, réglage en inclinaison et en hauteur	Árbol de dirección reclinable y de altura regulable	Piantone dello sterzo, inclinabile e regolabile in altezza	Coluna de direção, inclinável e ajustável em altura		●
Automatic air conditioning system	Klimaanlage	Climatisation	Aire acondicionado	Impianto di climatizzazione	Ar condicionado	●	
Independent heating system	Standheizung	Chauffage auxiliaire	Calefacción independiente	Riscaldamento indipendente	Aquecimento independente		●
Multi-function display	Multifunktionsdisplay	Écran multifonction	Pantalla multifuncional	Display multifunzione	Visor multifunções	●	
Document net	Dokumentennetz	Réseau de documents	Red de documentos	Rete per documenti	Rede para documentos	●	
FOPS Guard	Dachschutzgitter	Grille de protection sur le toit	Rejilla protectora de techo	Griglia di protezione tetto	Grade de proteção do tejadilho		●
Front and FOPS Guard	Front- und Dachschutzgitter	Protection frontale et de toit	Reja de protección frontal y en el techo	Griglia frontale e protezione tetto	Grade de proteção frontal e do tejadilho		●
12V transformer	Spannungswandler 12 V	Transformateur 12 V	Transformador de tensión de 12 V	Trasformatore 12 V	Transformador de 12 V		●
Radio USB & Bluetooth (EU & USA)	Radio USB & Bluetooth (EU & USA)	Radio USB et Bluetooth (UE et E.-U.)	Radio USB y Bluetooth (UE y EE. UU.)	Radio USB e Bluetooth (EU e USA)	Rádio USB e Bluetooth (UE e USA)	●	
12V socket	12 V Steckdose	Prise femelle 12 V	Enchufes de 12 V	Presa 12 V	Tomada de 12 V		●
Fire extinguisher, dry powder	Pulverfeuerlöscher in Kabine	Extincteur à poudre dans la cabine	Extintor de polvo químico en la cabina	Estintore a polvere in cabina	Extintor de incêndio na cabine		●
Travel alarm w/ rotating beacon	Warneinrichtung Fahren mit Rundumleuchte	Avertisseurs de conduite avec gyrophare	Dispositivo de aviso de marcha con faro giratorio	Dispositivo di avviso marcia con girofaro	Alarme de deslocamento com luz rotativa		●
OTHER EQUIPMENT	SONSTIGE AUSSTATTUNG	AUTRES ÉQUIPEMENTS	OTROS EQUIPOS	ATTREZZATURE OPTIONAL	OUTRO EQUIPAMENTO		
13 kW DC generator with controls	13 kW Gleichstrom-generator mit Steuerung	Génératrice de courant continu 13 kW avec commande	Generador de corriente continua de 13 kW con control	13 kW generatore a corrente continua con controllo	Dinamo de 13 kW com controle		●
17 kW DC generator with controls	17 kW Gleichstrom-generator mit Steuerung	Génératrice de courant continu 17 kW avec commande	Generador de corriente continua de 17 kW con control	17 kW generatore a corrente continua con controllo	Dinamo de 17 kW com controle		●
Close proximity range limiter for dipper stick	Nahbereichserweiterung für Ladestiel	Extension en zone proche pour balancier	Expansión de corto alcance para el balancín	Estensione area di prossimità con avambraccio	Limitador de proximidade para o braço de carga	●	
Coolant and hydraulic oil level monitoring system	Niveauewächter für Kühlmittel- und Hydraulikölstand	Contrôleurs de niveau de réfrigérant et d'huile hydraulique	Interruptores de nivel de líquido refrigerante y de aceite hidráulico	Controllo di livello olio idraulico e refrigerante	Medidores de nível de líquido de refrigeração e fluido hidráulico	●	
Filter system for attachments	Werkzeugfilter-System	Système de filtre outil	Sistema de herramienta de filtro	Sistema di filtro utensili	Sistema de filtro de ferramentas		●
Filter system for attachments (FQC)	Werkzeugfilter-System (FQC)	Système de filtre outil (FQC)	Sistema de herramienta de filtro (FQC)	Sistema di filtro utensili (FQC)	Sistema de filtro de ferramentas (FQC)	●	
Hose rupture valves for boom cylinder	Rohrbruchsicherung für Hubzylinder	Clapet de sécurité pour cylindre de levage	Seguro contra rotura de tubo para el cilindro de elevación	Valvola di arresto automatica per cilindro di sollevamento	Proteção contra rupturas do macaco hidráulico		●
Hose rupture valves for stick cylinder	Rohrbruchsicherung für Stielzylinder	Clapet de sécurité pour vérin de balancier	Seguro contra rotura de tubo para el balancín	Valvola di arresto automatica per cilindro dell'avambraccio	Proteção contra rupturas do cilindro da haste		●
Overload warning device	Überlastwarneinrichtung	avertisseur de surcharge,	Dispositivo de aviso de sobrecarga	Dispositivo di rilevazione e segnalazione di sovraccarico	Dispositivo de aviso de sobrecarga		●
Quick coupling on dipper stick	Schnellverschlusskupplung am Ladestiel	Connexion à fermeture rapide sur le balancier	Acoplamiento rápido en el balancín	Accoppiamento a chiusura rapida con avambraccio	Acoplamento de fecho rápido no braço de carga	●	
Dipper stick impact protection	Schlagschutz am Ladestiel	Protection sur le balancier	Protección contra golpes en el balancín	Protezione anticollisione avambraccio	Proteção contra choques no braço de carga		●
Active cyclone prefilter (TOP AIR)	Aktiver Zyklonvorabscheider für Luftfilter	Préséparateur cyclonique actif pour filtre à air	Ciclón separador previo activo para el filtro de aire	Primo separatore attivo a ciclone con filtro aria	Pré-separador ciclônico ativo para filtro de ar		●
Hydraulic oil preheating	Hydraulikölvorwärmung	Préchauffage de l'huile hydraulique	Pre calentamiento del aceite hidráulico	Preriscaldamento dell'olio idraulico	Pré-aquecimento do óleo hidráulico		●
Lubrication of the grab suspension by central lubrication system	Schmierung der Greifer-aufhängung über Zentral-schmieranlage	Graissage de la suspension du grappin à travers le système de graissage central	Lubricación del soporte de la cuchara por medio del dispositivo de lubricación central	Lubrificazione della sospensione benna mediante impianto di lubrificazione centrale	Lubrificação da suspensão do balde articulado através do sistema de lubrificação central	●	
Light packages LED	LED-Lichtpakete	Bloc lumière LED	Paquete de luces LED	Gruppi di luci LED	Pacotes de luzes LED		●
LED front headlights	LED-Scheinwerfer an Maschinenfront	Phare LED à l'avant de la machine	Faros LED en el frontal de la máquina	Fari LED sulla parte anteriore della macchina	Faróis LED na frente da máquina	●	
LED working lights cabin roof front	LED-Arbeitscheinwerfer am Kabinendach vorne	Phare de travail LED sur le toit de la cabine avant	Faros de trabajo LED en la parte frontal del techo de la cabina	Fari di lavoro LED sul tetto cabina anteriore	Faróis de trabalho LED no tejadilho da cabine, dianteira	●	
Boom cylinder damping system (piston accumulator)	Hubzylinderdämpfung (Kolbenspeicher)	Vérin de levage amorti (accumulateur à piston)	Amortiguación del cilindro de elevación (acumulador de pistón)	Ammortizzatore cilindro di sollevamento (serbatoio pistone)	Amortecimento do macaco hidráulico (acumulador de pistão)		●
Fuchs Telematics System, incl. 2 years contract	Fuchs Telematics System, inkl. 2 Jahre Nutzung	Système télématique Fuchs, avec entretien 2 ans	Sistema telemático de Fuchs, incluidos 2 años de servicio	Sistema Fuchs Telematics, con 2 anni di assistenza	Fuchs Telematics System, incl. 2 anos de manutenção	●	

DIMENSIONS | ABMESSUNGEN | DIMENSIONS | DIMENSIONES | DIMENSIONI | DIMENSÕES [mm]

4-point stabilizers | 4-Punkt-Abstützung | 4 stabilisateurs | Apoyo de 4 puntos | Sostegno a 4 punti | Apoio em 4 pontos

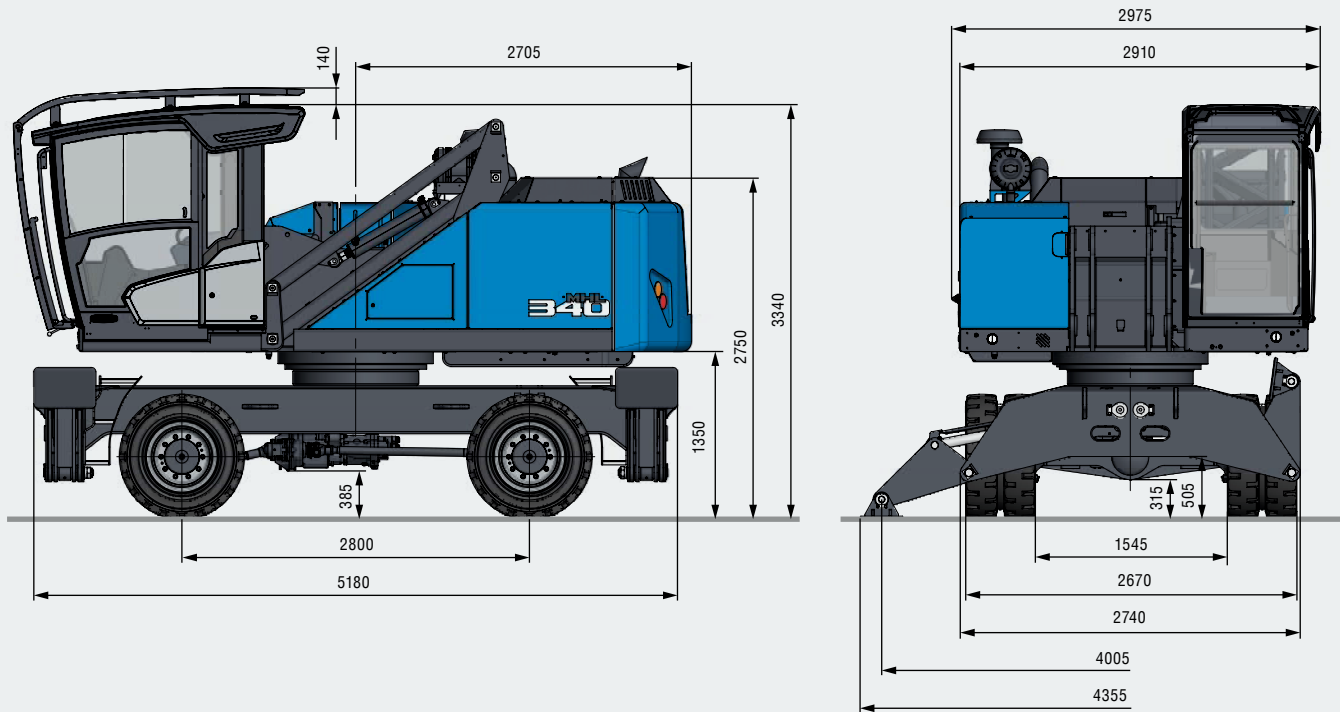

Dozer blade in addition to 4-point stabilizers
 Räumschild zusätzlich zur 4-Punkt-Abstützung
 Lame de remblayage en complément aux 4 stabilisateurs
 Pala adicional al apoyo de 4 puntos
 Lama livellatrice accessoria al sostegno a 4 punti
 Lâmina para além do apoio em 4 pontos

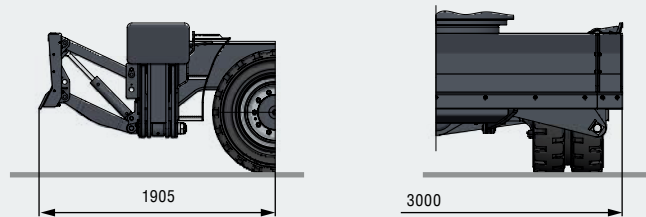

TRANSPORT DIMENSIONS | TRANSPORTABMESSUNGEN | DIMENSIONS DE TRANSPORT [mm]
DIMENSIONES DE TRANSPORTES | DIMENSIONI DE TRASPORTO | DIMENSÕES DE TRANSPORTE [mm]

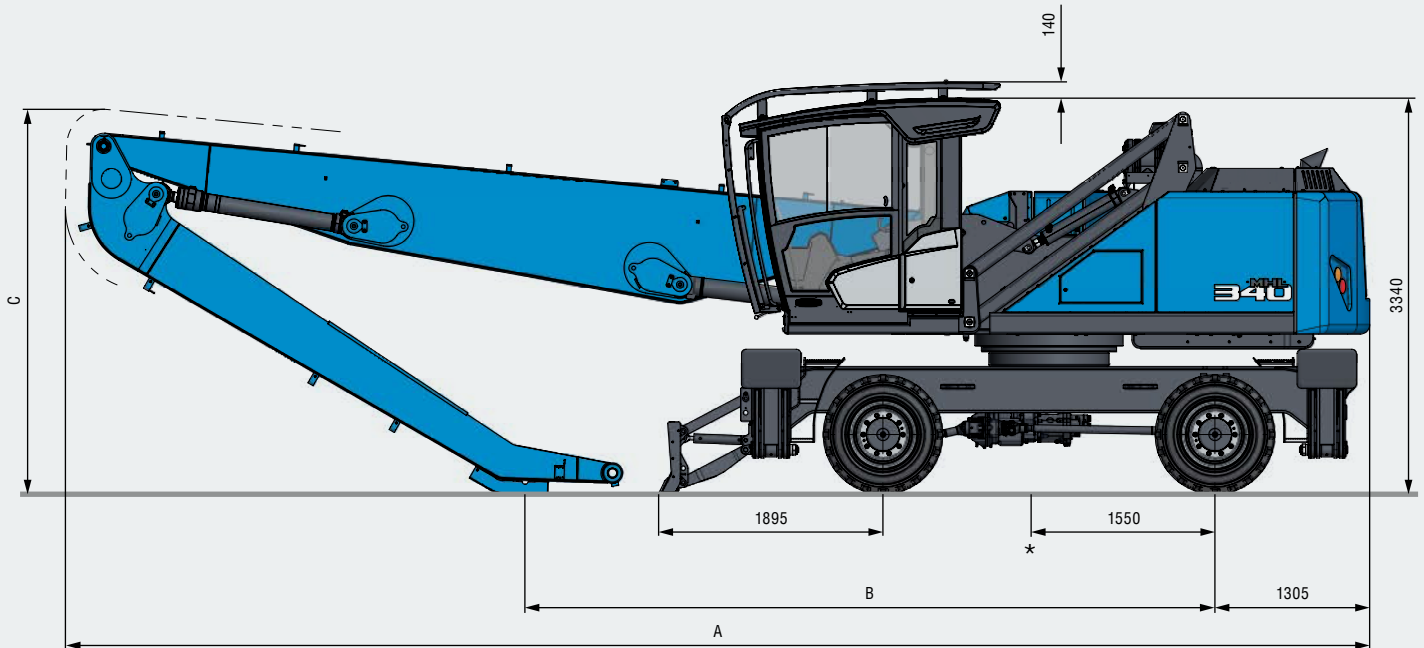

Transport position with dozer blade; undercarriage rotated by 180°
 Transportstellung mit Räumschild; Unterwagen um 180° gedreht
 Position de transport avec lame de remblayage ; châssis tourné de 180°
 Posición de transporte con pala; carro inferior girado 180°
 Posizione di trasporto con lama livellatrice, carrello ruotato di 180°
 Posição de transporte com lâmina; chassi com rotação a 180°

* Average center of gravity in transport position
 Gemittelte Schwerpunktlage in Transportstellung
 Position moyenne du centre de gravité en position de transport
 Centro de gravedad medio en la posición de transporte
 Punto medio del baricentro in posizione di trasporto
 Centro de gravidade calculado na posição de transporte

	12,2 m**	12,6 m	13,7 m
A	11200 mm	11000 mm	11005 mm
B	6009 mm	5820 mm	4800 mm
C	3111 mm	3250 mm	3085 mm

** Multi-purpose stick | Mehrzweckstiel | Balancier à usage multiple | Barra de usos múltiples | Avambraccio universale | Balançoero multiuso

MHL340 F FQC

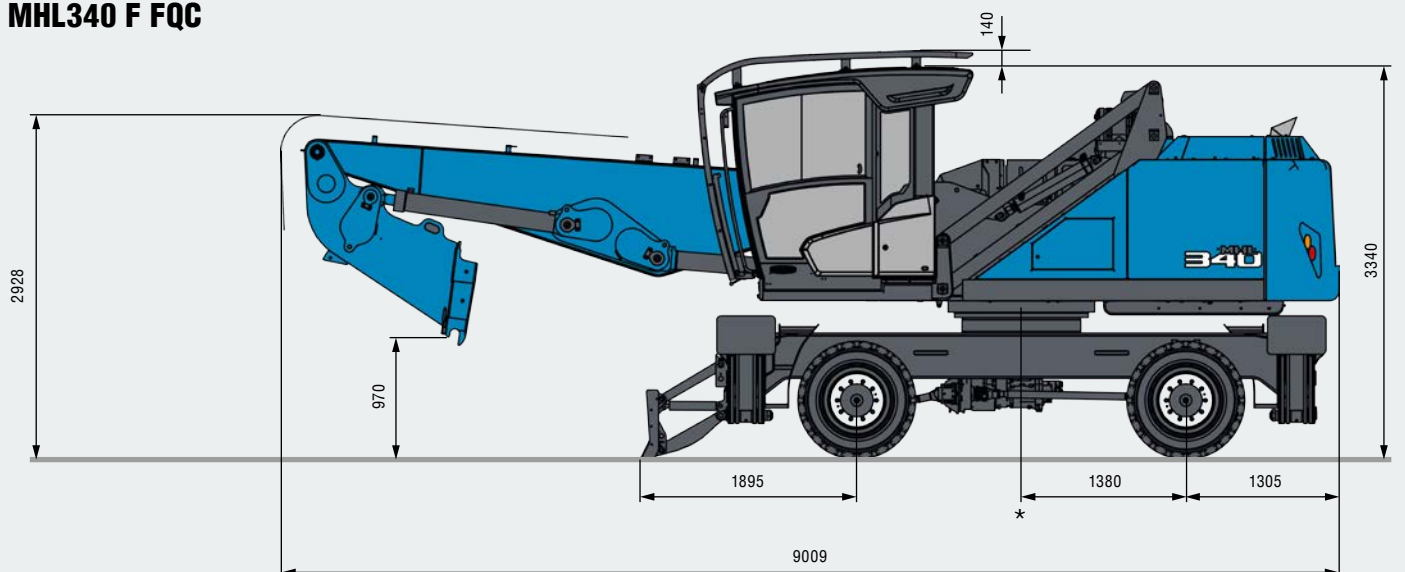









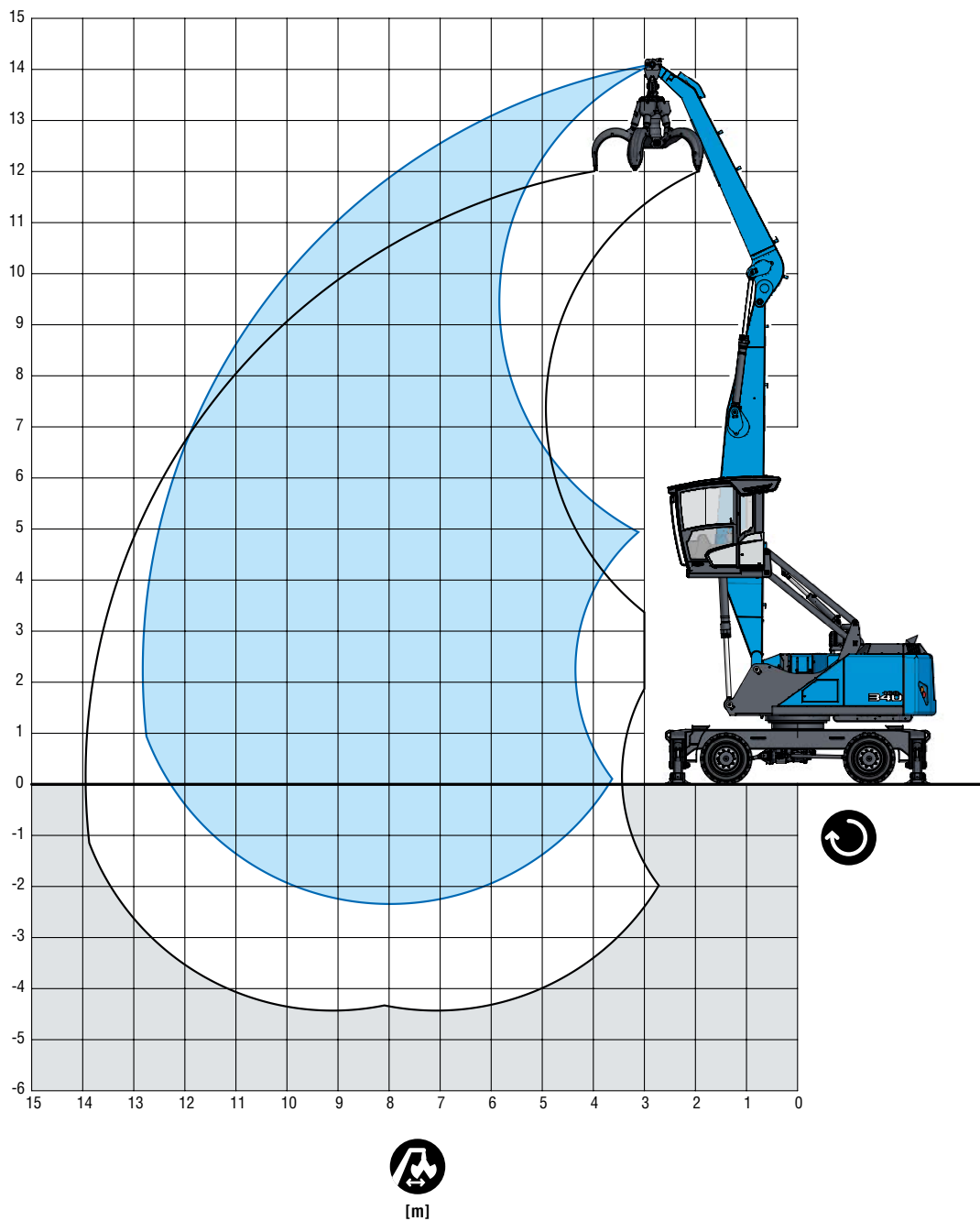



















12,6 m

With dipper stick | Mit Ladestiel | Avec balancier
Con balancín | Con avambraccio industriale | Com braço de carga

LOADING EQUIPMENT	LADEEINRICHTUNG	ÉQUIPEMENT CHARGEUR	EQUIPO DE CARGA	PALA CARICATRICE	EQUIPAMENTO DE CARGA	
Boom	Ausleger	Flèche de type caisson	Pluma tipo caja	Braccio	Lança	7,2 m
Dipper stick	Ladestiel	Balancier	Balancín	Avambraccio industriale	Braço de carga	5,1 m
Cactus grab	Mehrschalengreifer	Grappin cactus	Pulpo	Polipo multivalve	Garra de abertura de poços	0,6 m³



Lifting capacity | Traglast | Capacité de charge | Capacidad de carga | Capacità di carico | Capacidade de carga

							
		4,5 m	6 m	7,5 m	9 m	10,5 m	12 m
13,5 m	 	(6,3°) 6,3° (6,3°)					
12 m	 		(6,6°) 6,6° (6,6°)	(4,7°) 4,7° (4,7°)			
10,5 m	 		(7,5°) 7,5° (7,5°)	(5,6°) 6,5° (6,5°)	(4,1°) 4,7° (4,7°)		
9 m	 		(8,0°) 8,0° (8,0°)	(5,7°) 7,5° (7,5°)	(4,2°) 6,3° (6,3°)	(3,2°) 4,3° (4,3°)	
7,5 m	 		(8,0°) 8,7° (8,7°)	(5,6°) 7,7° (7,7°)	(4,1°) 6,3° (6,6°)	(3,2°) 4,9° (5,6°)	
6 m	 	(9,3°) 9,3° (9,3°)	(7,7°) 9,6° (9,6°)	(5,4°) 7,9° (7,9°)	(4,0°) 6,2° (6,8°)	(3,1°) 4,8° (5,8°)	(2,5°) 3,7° (4,1°)
4,5 m	 	(11,3°) 14,1° (14,1°)	(7,2°) 10,4° (10,4°)	(5,1°) 8,0° (8,3°)	(3,9°) 6,0° (6,9°)	(3,0°) 4,7° (5,9°)	(2,4°) 3,8° (4,8°)
3	 	(10,0°) 15,8° (15,8°)	(6,6°) 10,7° (11,1°)	(4,8°) 7,6° (8,6°)	(3,7°) 5,8° (7,0°)	(2,9°) 4,6° (5,7°)	(2,4°) 3,8° (4,7°)
1,5	 	(5,4°) 5,4° (5,4°)	(6,1°) 10,2° (11,3°)	(4,5°) 7,3° (8,6°)	(3,5°) 5,6° (6,9°)	(2,8°) 4,5° (5,6°)	(2,3°) 3,7° (4,5°)
0 m	 	(4,8°) 4,8° (4,8°)	(5,8°) 9,9° (10,6°)	(4,3°) 7,1° (8,2°)	(3,4°) 5,5° (6,6°)	(2,8°) 4,4° (5,2°)	(2,3°) 3,7° (3,9°)
-1,5 m	 		(5,7°) 9,1° (9,1°)	(4,2°) 7,0° (7,3°)	(3,3°) 5,4° (5,8°)	(2,7°) 4,4° (4,5°)	
							max. máx. 12,8 m
2,3 m	 						(2,1°) 3,2° (3,2°)



Important notes regarding the load capacities → Page 03 | Wichtige Erläuterungen zu den Traglasten → Seite 03 | Précisions importantes sur les charges → Page 03
 Consideraciones importantes sobre las cargas → Página 03 | Spiegazioni importanti sui carichi massimi → Pagina 03 | Explicações importantes sobre as capacidades de carga → Página 03

RECOMMENDED ATTACHMENTS	EMPFOHLENE ANBAUGERÄTE	ÉQUIPEMENTS RECOMMANDÉS	ACCESORIOS RECOMENDADOS	ATTREZZI CONSIGLIATI	ACESSÓRIOS RECOMENDADOS
Recommended attachments upon request	Anbaugeräte auf Anfrage	Grappins recommandés sur demande	Recomendaciones de pulpos a petición	Consigli per la scelta della benna a richiesta	Recomendações sobre garras sob consulta









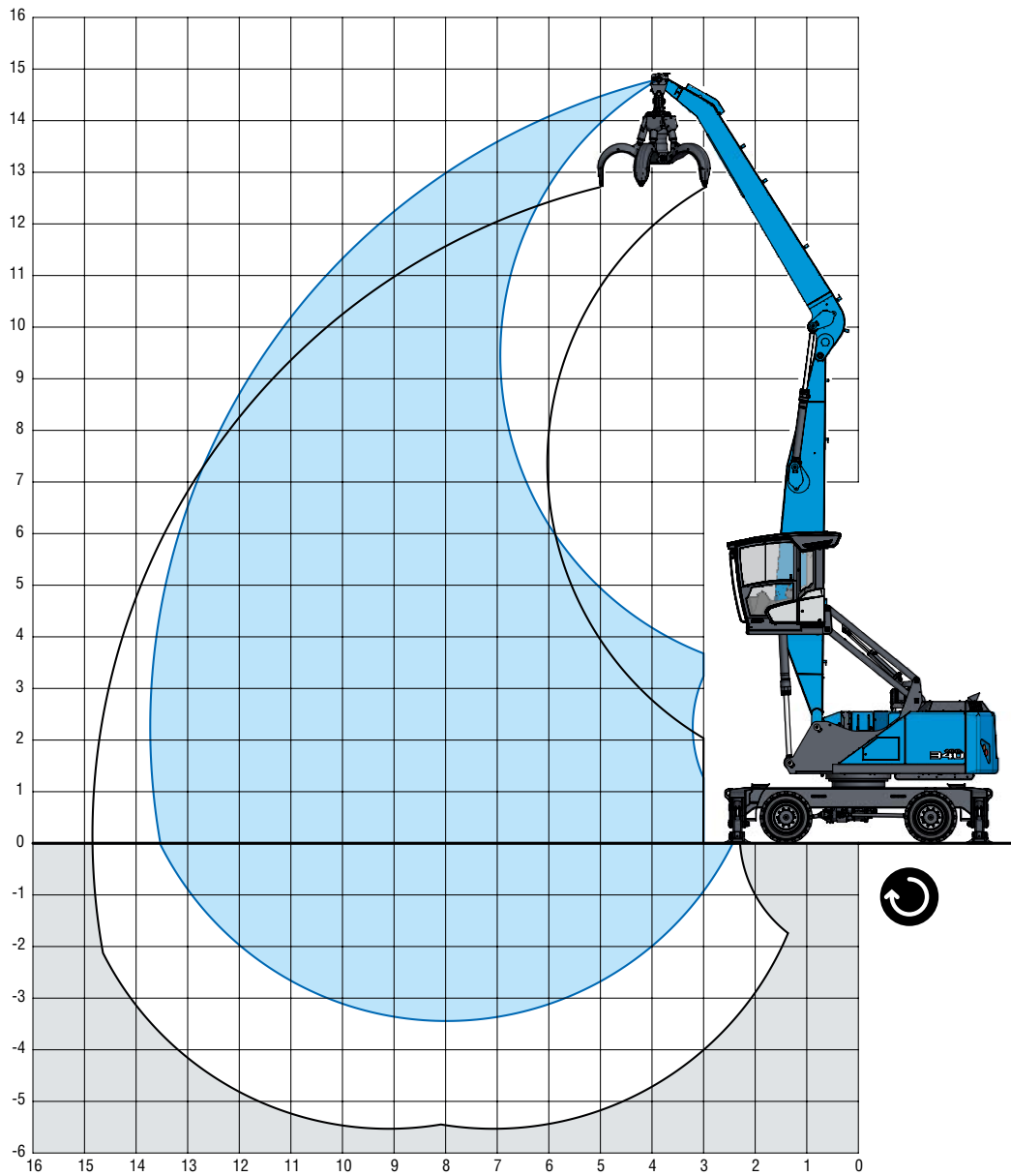





















13,7 m

With dipper stick | Mit Ladestiel | Avec balancier
Con balancín | Con avambraccio industriale | Com braço de carga

LOADING EQUIPMENT	LADEEINRICHTUNG	ÉQUIPEMENT CHARGEUR	EQUIPO DE CARGA	PALA CARICATRICE	EQUIPAMENTO DE CARGA	
Boom	Ausleger	Flèche de type caisson	Pluma tipo caja	Braccio	Lança	7,2 m
Dipper stick	Ladestiel	Balancier	Balancín	Avambraccio industriale	Braço de carga	6,2 m
Cactus grab	Mehrschalengreifer	Grappin cactus	Pulpo	Polipo multivalve	Garra de abertura de poços	0,6 m³



Lifting capacity | Traglast | Capacité de charge | Capacidad de carga | Capacità di carico | Capacidade de carga

								
		4,5 m	6 m	7,5 m	9 m	10,5 m	12 m	13,5 m
13,5 m	 		(4,5°) 4,5° (4,5°)					
12 m	 			(4,6°) 4,6° (4,6°)	(3,0°) 3,0° (3,0°)			
10,5 m	 			(5,4°) 5,4° (5,4°)	(4,3°) 4,5° (4,5°)	(2,7°) 2,7° (2,7°)		
9 m	 			(5,9°) 6,0° (6,0°)	(4,3°) 5,3° (5,3°)	(3,3°) 4,6° (4,6°)		
7,5 m	 			(5,8°) 6,7° (6,7°)	(4,2°) 6,1° (6,1°)	(3,2°) 4,9 (5,0°)	(2,5°) 3,6° (3,6°)	
6 m	 		(7,5°) 7,5° (7,5°)	(5,6°) 7,3° (7,3°)	(4,1°) 6,3° (6,3°)	(3,1°) 4,9 (5,5°)	(2,5°) 3,9 (4,7°)	
4,5 m	 	(8,8°) 8,8° (8,8°)	(7,5°) 9,5° (9,5°)	(5,3°) 7,7° (7,7°)	(3,9°) 6,1 (6,5°)	(3,0°) 4,7 (5,6°)	(2,4°) 3,8 (4,7)	(1,9°) 2,3° (2,3°)
3 m	 	(10,8°) 14,3° (14,3°)	(6,9°) 10,4° (10,4°)	(4,9°) 7,8 (8,1°)	(3,7°) 5,8 (6,7°)	(2,9°) 4,6 (5,7°)	(2,3°) 3,7 (4,7)	(1,9°) 2,9° (2,9°)
1,5 m	 	(9,4°) 14,5° (14,5°)	(6,3°) 10,4 (10,9°)	(4,6°) 7,4 (8,4°)	(3,5°) 5,6 (6,8°)	(2,8°) 4,5 (5,6)	(2,2°) 3,7 (4,6)	(1,9°) 3,0° (3,0°)
0 m	 	(6,8°) 6,8° (6,8°)	(5,8°) 9,8 (10,8°)	(4,3°) 7,0 (8,3°)	(3,3°) 5,4 (6,6°)	(2,7°) 4,3 (5,4°)	(2,2°) 3,6 (4,3°)	(1,8°) 2,5° (2,5°)
-1,5 m	 	(6,0°) 6,0° (6,0°)	(5,5°) 9,5 (10,0°)	(4,1°) 6,8 (7,7°)	(3,2°) 5,3 (6,2°)	(2,6°) 4,3 (4,9°)	(2,1°) 3,5 (3,8°)	
-3 m	 		(5,5°) 8,3° (8,3°)	(4,0°) 6,6° (6,6°)	(3,1°) 5,2° (5,2°)			
max. máx. 13,7 m								
2,3 m	 							(1,8°) 2,3° (2,3°)



Important notes regarding the load capacities → Page 03 | Wichtige Erläuterungen zu den Traglasten → Seite 03 | Précisions importantes sur les charges → Page 03
 Consideraciones importantes sobre las cargas → Página 03 | Spiegazioni importanti sui carichi massimi → Pagina 03 | Explicações importantes sobre as capacidades de carga → Página 03

RECOMMENDED ATTACHMENTS	EMPFOHLENE ANBAUGERÄTE	ÉQUIPEMENTS RECOMMANDÉS	ACCESORIOS RECOMENDADOS	ATTREZZI CONSIGLIATI	ACESSÓRIOS RECOMENDADOS
Recommended attachments upon request	Anbaugeräte auf Anfrage	Grappins recommandés sur demande	Recomendaciones de pulpos a petición	Consigli per la scelta della benna a richiesta	Recomendações sobre garras sob consulta



12,2 m

With multi-purpose stick | Mit Mehrzweckstiel | Avec balancier à usage multiple
 Con barra de usos múltiples | Con avambraccio universale | Com balanceiro multiuso

LOADING EQUIPMENT	LADEEINRICHTUNG	ÉQUIPEMENT CHARGEUR	EQUIPO DE CARGA	PALA CARICATRICE	EQUIPAMENTO DE CARGA	
Boom	Ausleger	Flèche de type caisson	Pluma tipo caja	Braccio	Lança	7,2 m
Multi-purpose stick	Mehrzweckstiel	Balancier à usage multiple	Barra de usos múltiples	Avambraccio universale	Balanceiro multiuso	4,5 m
Sorting grapple	Sortiergreifer	Benne trieuse	Pala clasificadora	Benna selezionatrice	Garra de separação	

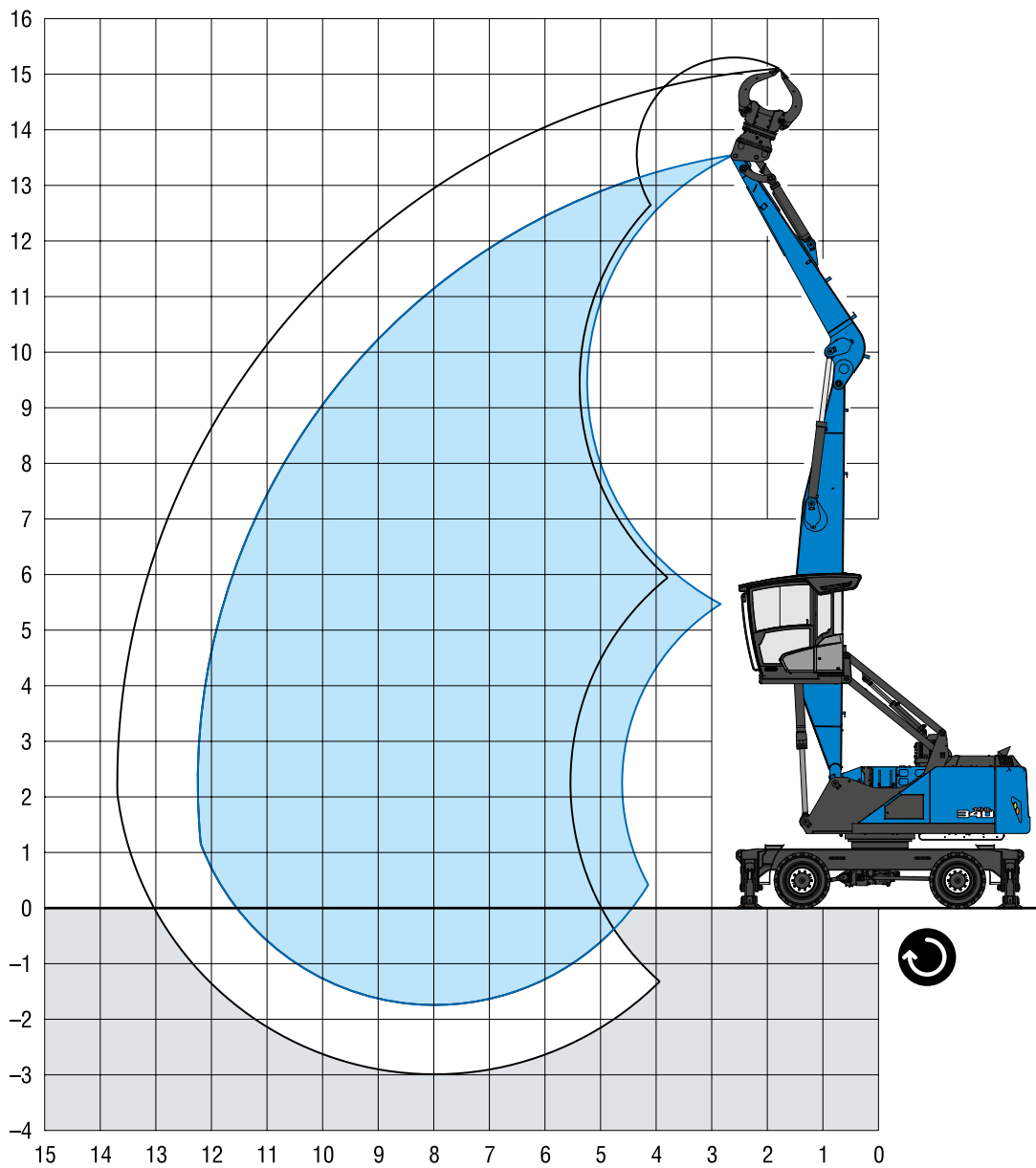

Lifting capacity | Traglast | Capacité de charge | Capacidad de carga | Capacità di carico | Capacidade de carga

								12 m	
			3 m	4,5 m	6 m	7,5 m	9 m		
13,5 m			(7,7°) 7,7° (7,7°)						
12 m				(8,0°) 8,0° (8,0°)	(6,3°) 6,3° (6,3°)				
10,5 m					(7,8) 7,9° (7,9°)	(5,3) 6,4° (6,4°)			
9 m					(7,8) 8,8° (8,8°)	(5,3) 7,6° (7,6°)	(3,9) 6,0° (6,1°)		
7,5 m					(7,6) 9,2° (9,2°)	(5,2) 7,6° (7,6°)	(3,8) 6,0 (6,5°)	(2,9) 4,6 (4,9°)	
6 m				(11,6) 11,8° (11,8°)	(7,2) 9,8° (9,8°)	(5,0) 7,9° (7,9°)	(3,7) 5,9 (6,6°)	(2,8) 4,5 (5,6°)	
4,5 m				(10,5) 14,6° (14,6°)	(6,7) 10,5° (10,5°)	(4,8) 7,6 (8,2°)	(3,6) 5,7 (6,7°)	(2,8) 4,5 (5,6°)	(2,2) 3,1° (3,1°)
3 m					(6,2) 10,3 (10,9°)	(4,5) 7,3 (8,3°)	(3,4) 5,5 (6,7°)	(2,7) 4,4 (5,5°)	(2,1) 3,5 (4,2°)
1,5 m					(5,7) 9,8 (10,7°)	(4,2) 7,0 (8,2°)	(3,3) 5,3 (6,5°)	(2,6) 4,3 (5,2°)	(2,1) 3,5 (3,8°)
0 m				(4,1°) 4,1° (4,1°)	(5,5) 9,5 (9,7°)	(4,1) 6,8 (7,6°)	(3,1) 5,2 (6,0°)	(2,5) 4,2 (4,6°)	
-1,5 m						(4,0) 6,4° (6,4°)	(3,1) 5,0° (5,0°)		
								max. máx. 12,2 m	
2,3 m								(2,0) 3,4° (3,4°)	



Important notes regarding the load capacities → Page 03 | Wichtige Erläuterungen zu den Traglasten → Seite 03 | Précisions importantes sur les charges → Page 03
 Consideraciones importantes sobre las cargas → Página 03 | Spiegazioni importanti sui carichi massimi → Pagina 03 | Explicações importantes sobre as capacidades de carga → Página 03

RECOMMENDED ATTACHMENTS	EMPFOHLENE ANBAUGERÄTE	ÉQUIPEMENTS RECOMMANDÉS	ACCESORIOS RECOMENDADOS	ATTREZZI CONSIGLIATI	ACESSÓRIOS RECOMENDADOS
Recommended attachments upon request	Anbaugeräte auf Anfrage	Grappins recommandés sur demande	Recomendaciones de pulpos a petición	Consigli per la scelta della benna a richiesta	Recomendações sobre garras sob consulta









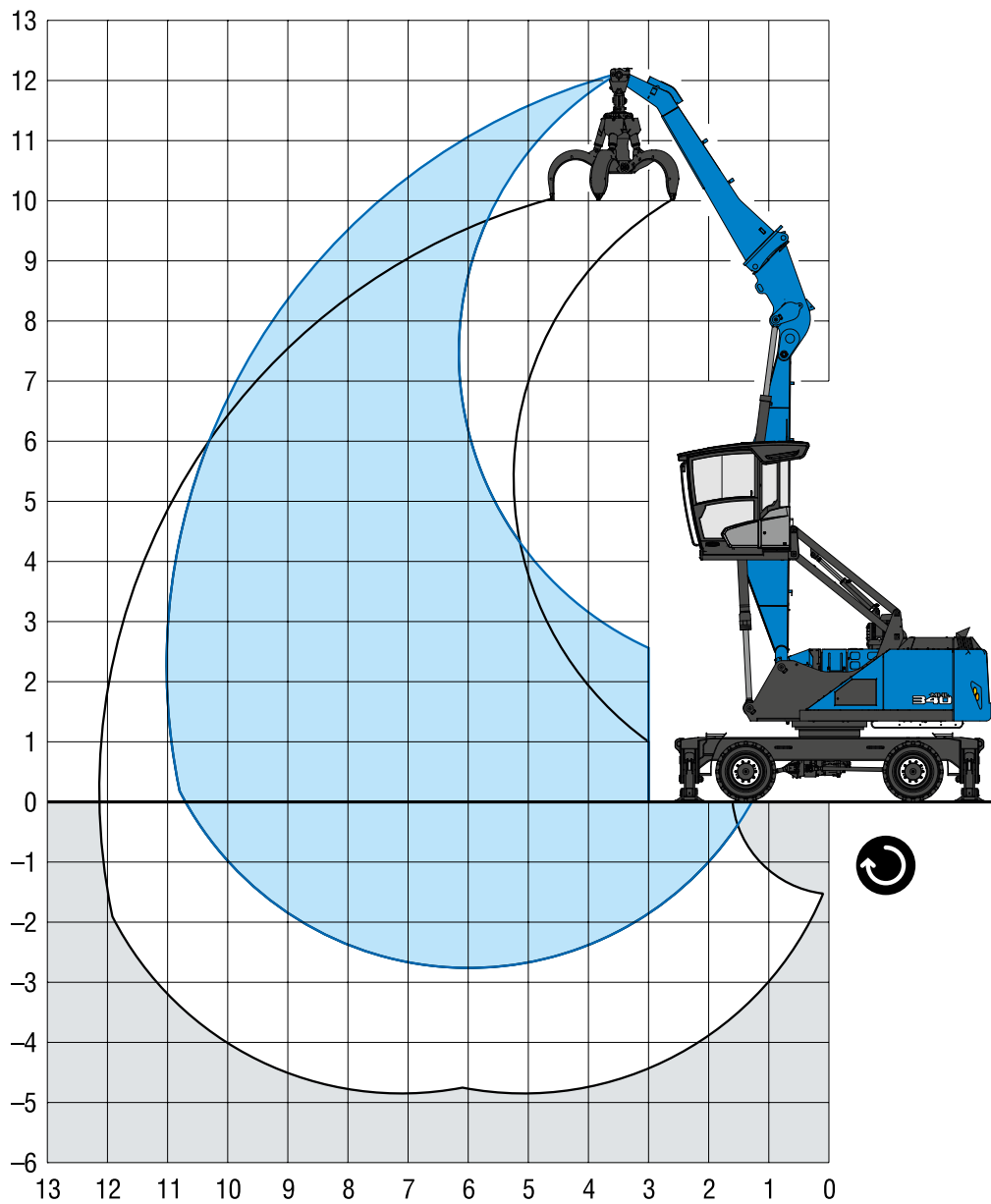















11,0 m

With dipper stick | Mit Ladestiel | Avec balancier
Con balancín | Con avambraccio industriale | Com braço de carga

LOADING EQUIPMENT FQC	LADEINRICHTUNG FQC	ÉQUIPEMENT CHARGEUR FQC	EQUIPO DE CARGA FQC	PALA CARICATRICE FQC	EQUIPAMENTO DE CARGA FQC	
Boom	Ausleger	Flèche de type caisson	Pluma tipo caja	Braccio	Lança	5,2 m
Dipper stick	Ladestiel	Balancier	Balancín	Avambraccio industriale	Braço de carga	5,4 m
Cactus grab with Fuchs QuickConnect	Mehrschalengreifer mit Schnellwechsel Fuchs QuickConnect	Grappin multicoque avec attache rapide Fuchs QuickConnect	Cuchara pólipa con enganche rápido Fuchs QuickConnect	Benna polipo con attacco rapido Fuchs QuickConnect	Garra de mandíbulas múltiples com troca rápida Fuchs QuickConnect	0,6 m ³



Lifting capacity | Traglast | Capacité de charge | Capacidad de carga | Capacità di carico | Capacidade de carga

							
		3 m	4,5 m	6 m	7,5 m	9 m	10,5 m
10,5 m	 			(5,0°) 5,0° (5,0°)			
9 m	 			(6,6°) 6,6° (6,6°)	(4,9°) 4,9° (4,9°)		
7,5 m	 				(5,2) 6,3° (6,3°)	(3,7) 4,0° (4,0°)	
6 m	 			(7,7) 8,0° (8,0°)	(5,2) 7,3° (7,3°)	(3,7) 5,5° (5,5°)	
4,5 m	 			(7,3) 9,0° (9,0°)	(5,0) 7,7° (7,7°)	(3,6) 5,7 (6,7°)	(2,6) 3,3° (3,3°)
3 m	 		(11,1) 11,8° (11,8°)	(6,8) 10,0° (10,0°)	(4,7) 7,5 (8,1°)	(3,4) 5,5 (6,8°)	(2,6) 4,2° (4,2°)
1,5 m	 	(19,6) 25,5° (25,5°)	(9,7) 15,1° (15,1°)	(6,2) 10,3 (10,9°)	(4,3) 7,1 (8,5°)	(3,2) 5,3 (6,7°)	(2,5) 4,1 (5,2°)
0 m	 	(7,7°) 7,7° (7,7°)	(8,7) 15,8° (15,8°)	(5,7) 9,6 (11,0°)	(4,1) 6,8 (8,3°)	(3,1) 5,1 (6,4°)	(2,5) 3,9 (3,9°)
-1,5 m	 	(7,0°) 7,0° (7,0°)	(8,2) 14,3° (14,3°)	(5,4) 9,3 (10,1°)	(3,9) 6,6 (7,5°)	(3,0) 5,1 (5,4°)	
							max. máx. 11,0 m
2,3 m	 						(2,3°) 2,3° (2,3°)



Important notes regarding the load capacities → Page 03 | Wichtige Erläuterungen zu den Traglasten → Seite 03 | Précisions importantes sur les charges → Page 03
 Consideraciones importantes sobre las cargas → Página 03 | Spiegazioni importanti sui carichi massimi → Pagina 03 | Explicações importantes sobre as capacidades de carga → Página 03

RECOMMENDED ATTACHMENTS	EMPFOHLENE ANBAUGERÄTE	ÉQUIPEMENTS RECOMMANDÉS	ACCESORIOS RECOMENDADOS	ATTREZZI CONSIGLIATI	ACESSÓRIOS RECOMENDADOS
Recommended attachments upon request	Anbaugeräte auf Anfrage	Grappins recommandés sur demande	Recomendaciones de pulpos a petición	Consigli per la scelta della benna a richiesta	Recomendações sobre garras sob consulta









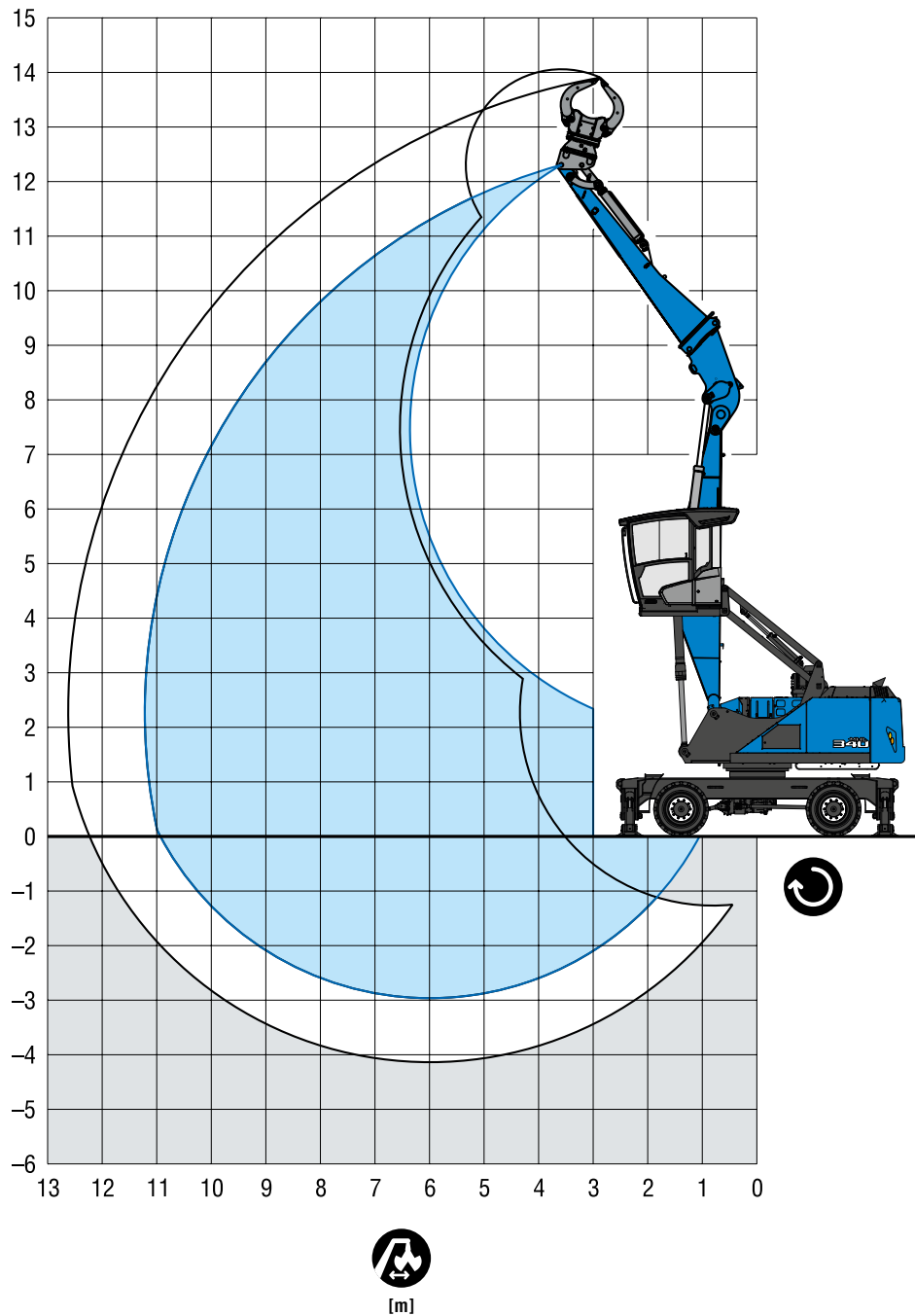















11,2 m

With multi-purpose stick | Mit Mehrzweckstiel | Avec balancier à usage multiple
Con barra de usos múltiples | Con avambraccio universale | Com balanceiro multiuso

LOADING EQUIPMENT FQC	LADEEINRICHTUNG FQC	ÉQUIPEMENT CHARGEUR FQC	EQUIPO DE CARGA FQC	PALA CARICATRICE FQC	EQUIPAMENTO DE CARGA FQC	
Boom	Ausleger	Flèche de type caisson	Pluma tipo caja	Braccio	Lança	5,2 m
Multi-purpose stick	Mehrzweckstiel	Balancier à usage multiple	Barra de usos múltiples	Avambraccio universale	Balanceiro multiuso	5,6 m
Sorting grab with Fuchs QuickConnect	Sortiergreifer mit Schnellwechsel Fuchs QuickConnect	Benne trieuse avec attache rapide Fuchs QuickConnect	Pala clasificadora con enganche rápido Fuchs QuickConnect	Benna selezionatrice con attacco rapido Fuchs QuickConnect	Garra de separação com troca rápida Fuchs QuickConnect	



Lifting capacity | Traglast | Capacité de charge | Capacidad de carga | Capacità di carico | Capacidade de carga

							
		3 m	4,5 m	6 m	7,5 m	9 m	10,5 m
10,5 m	 			(5,0°) 5,0° (5,0°)			
9 m	 				(4,8) 4,8° (4,8°)		
7,5 m	 				(5,1) 5,9° (5,9°)	(3,5) 4,0° (4,0°)	
6 m	 				(5,0) 6,8° (6,8°)	(3,5) 5,3° (5,3°)	(2,0) 2,0° (2,0°)
4,5 m	 			(7,2) 8,4° (8,4°)	(4,8) 7,3° (7,3°)	(3,4) 5,5 (6,3°)	(2,5) 3,4° (3,4°)
3 m	 		(10,2°) 10,2° (10,2°)	(6,7) 9,4° (9,4°)	(4,5) 7,3 (7,7°)	(3,2) 5,3 (6,4°)	(2,4) 4,0° (4,2°)
1,5 m	 	(20,0) 24,3° (24,3°)	(9,7) 14,4° (14,4°)	(6,0) 10,1° (10,3°)	(4,2) 7,0 (8,0°)	(3,0) 5,1 (6,4°)	(2,3) 3,9° (4,6°)
0 m	 	(8,1°) 8,1° (8,1°)	(8,5) 15,4° (15,4°)	(5,5) 9,5 (10,6°)	(3,9) 6,6 (8,0°)	(2,9) 4,9 (6,1°)	(2,2) 3,9° (4,2°)
-1,5 m	 	(6,8°) 6,8° (6,8°)	(7,9) 14,2° (14,2°)	(5,1) 9,1 (9,9°)	(3,7) 6,4 (7,3°)	(2,7) 4,8 (5,3°)	
							max. máx. 11,2 m
2,3 m	 						(1,9°) 1,9° (1,9°)



Important notes regarding the load capacities → Page 03 | Wichtige Erläuterungen zu den Traglasten → Seite 03 | Précisions importantes sur les charges → Page 03

Consideraciones importantes sobre las cargas → Página 03 | Spiegazioni importanti sui carichi massimi → Pagina 03 | Explicações importantes sobre as capacidades de carga → Página 03

RECOMMENDED ATTACHMENTS	EMPFOHLENE ANBAUGERÄTE	ÉQUIPEMENTS RECOMMANDÉS	ACCESORIOS RECOMENDADOS	ATTREZZI CONSIGLIATI	ACESSÓRIOS RECOMENDADOS
Recommended attachments upon request	Anbaugeräte auf Anfrage	Grappins recommandés sur demande	Recomendaciones de pulpos a petición	Consigli per la scelta della benna a richiesta	Recomendações sobre garras sob consulta



11,2 m

With scrap shears | Mit Schrottschere | Avec cisaille à ferrailles
Con cizalla para chatarra | Cesoia per sfridi | Com tesoura de sucata

LOADING EQUIPMENT FQC	LADEINRICHTUNG FQC	ÉQUIPEMENT CHARGEUR FQC	EQUIPO DE CARGA FQC	PALA CARICATRICE FQC	EQUIPAMENTO DE CARGA FQC	
Boom	Ausleger	Flèche de type caisson	Pluma tipo caja	Braccio	Lança	5,2 m
Scrap shears GXP 300 with Fuchs QuickConnect	Schrottschere GXP 300R mit Schnellwechsel Fuchs QuickConnect	Cisaille à ferrailles GXP 300R avec attache rapide Fuchs QuickConnect	Cizalla para chatarra GXP 300R con enganche rápido Fuchs QuickConnect	Cesoia per sfridi GXP 300R con attacco rapido Fuchs QuickConnect	Tesoura de sucata GXP 300R com troca rápida Fuchs QuickConnect	

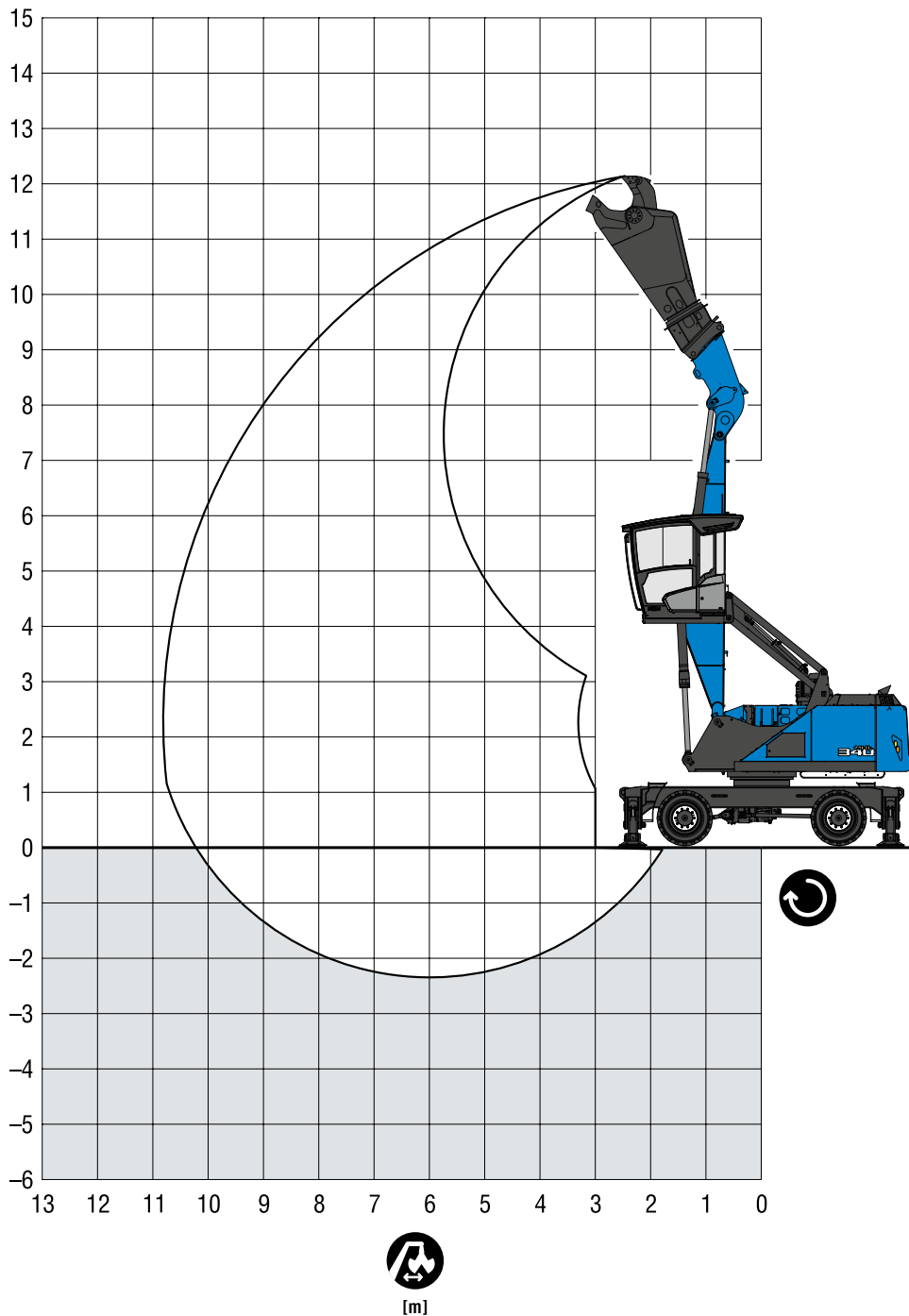

QuickConnect Systems

The unique QuickConnect system

Time is money – and with the QuickConnect systems, you can reduce attachment-change downtime to a fraction of the usual cost. For example, in less than a minute you can switch from a multi-purpose stick / grab combination to a dipper stick with a magnet or scrap shears. Using leak-free quick couplers, attachments can be changed quickly and safely from inside the cab. For the operator, climbing in and out and removing and replacing bolts are now just things of the past.

Le QuickConnect unique

Le temps, c'est de l'argent, et avec QuickConnect systèmes, la durée d'équipement lors du remplacement d'outil est réduite à une fraction de la durée habituelle. Il est par exemple possible de remplacer en moins d'une minute un balancier à usage multiple avec grappin, un balancier avec plaque magnétique ou une cisaille à ferrailles. Grâce aux raccords rapides étanches, les outils peuvent être remplacés de façon sûre et rapide à partir de la cabine. Ainsi, la montée et la descente du conducteur ainsi que la retenue compliquée des boulons font désormais partie du passé.

L'esclusivo QuickConnect

Il tempo è denaro: grazie a QuickConnect sistemi i tempi di sostituzione di un utensile vengono notevolmente ridotti e di conseguenza anche i costi. Ad esempio, in meno di un minuto è possibile sostituire un avambraccio universale con una benna mordente o un avambraccio con un disco magnetico o una cesoia per sfridi. Con gli attacchi rapidi a tenuta stagna, gli utensili vengono sostituiti in modo rapido e sicuro dalla cabina. L'accesso e la discesa del conducente e il complicato utilizzo dei bulloni appartengono al passato.

Das einmalige QuickConnect

Zeit ist Geld – und mit QuickConnect Systemen lässt sich die Rüstzeit beim Werkzeugwechsel auf einen Bruchteil des herkömmlichen Aufwands reduzieren. In weniger als einer Minute lassen sich damit beispielweise Mehrzweckstiel mit Greifer, Ladestiel mit Magnetplatte oder Schrottschere austauschen. Mit leckagefreien Schnellkupplungen werden die Werkzeuge schnell und sicher von der Kabine aus gewechselt. Das Auf- und Absteigen des Fahrers sowie das umständliche Hantieren mit Bolzen gehören damit der Vergangenheit an.

El sistema único QuickConnect

El tiempo es oro, y con QuickConnect sistemas el tiempo de preparación al cambiar de herramienta se puede reducir a una fracción del tiempo habitual. Permite sustituir en menos de un minuto la barra de usos múltiples por una cuchara, un balancín con placa magnética o una cizalla para chatarra, por ejemplo. Con los acoplamientos rápidos sin fugas, las herramientas se cambian desde la cabina de forma rápida y segura. La subida y bajada del conductor y los complejos trabajos con tornillos son ya cosa del pasado.

A QuickConnect única

Tempo é dinheiro e o sistema QuickConnect sistemas permite reduzir ao mínimo o tempo de troca de ferramenta. Em menos de um minuto, é possível, por exemplo, trocar balanceiros multiusos com garra, um braço de carga com placa magnética ou tesouras de sucata. Graças aos acoplamentos rápidos sem fugas, as ferramentas são trocadas a partir da cabine de forma rápida e segura. A entrada e saída do condutor, assim como o manuseio demorado de pinos, já fazem parte do passado.

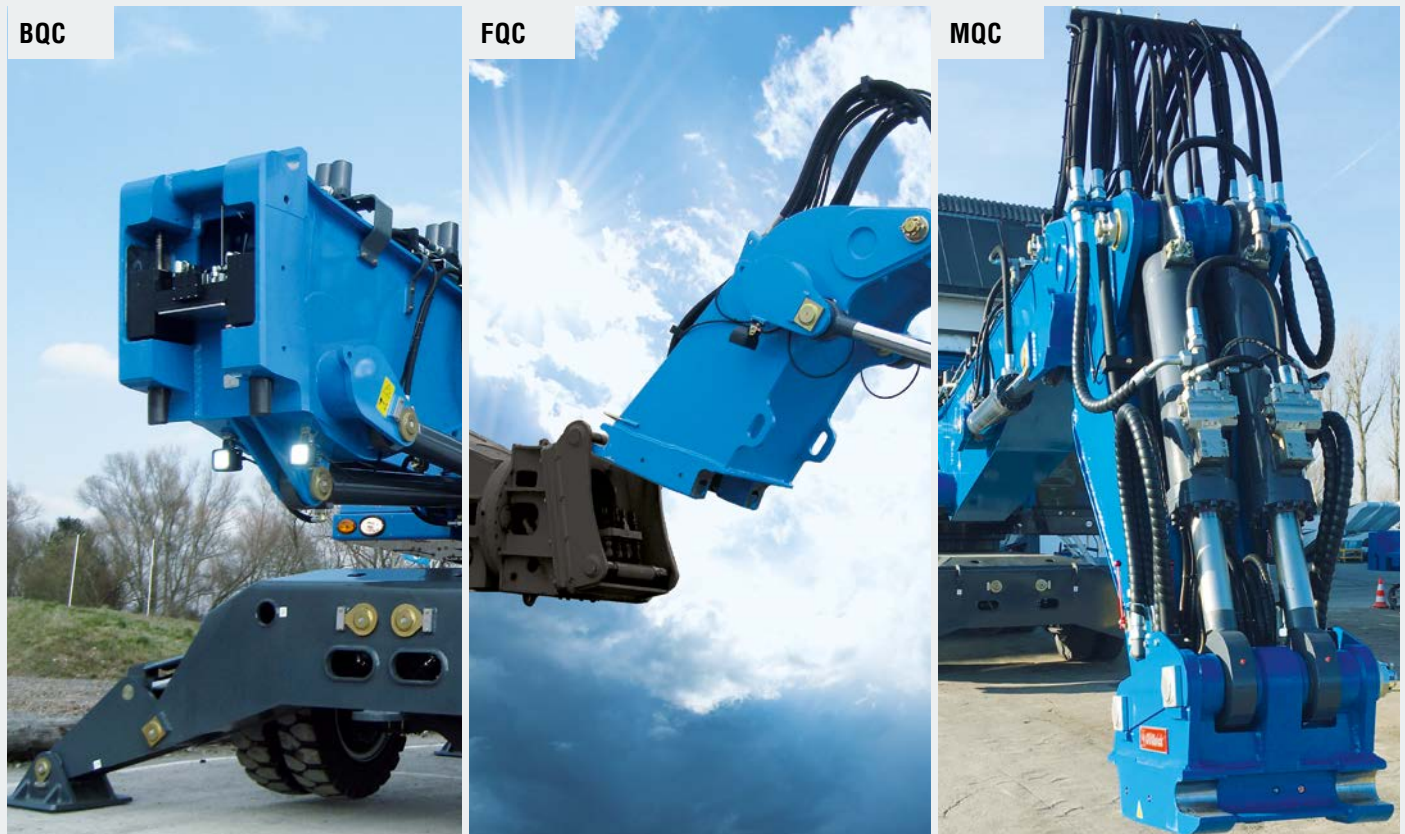

MODULAR SYSTEM

ATTACHMENTS



Cactus grab



Timber grapple



Magnet plate

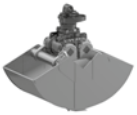

Clamshell grab



Load hook



LOADING EQUIPMENT



Straight

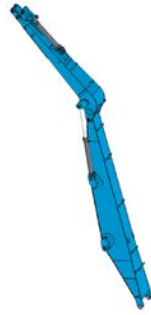

Universal stick

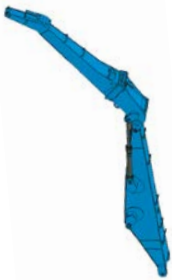

FQC
Fuchs QuickConnect



MQC
Multi QuickConnect

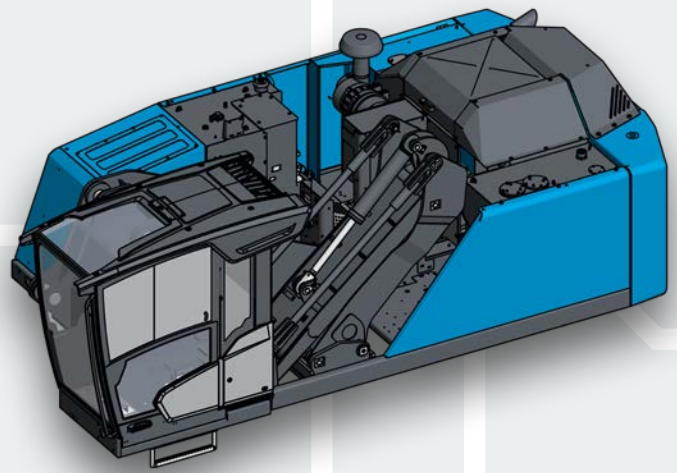

UNDERCARRIAGES

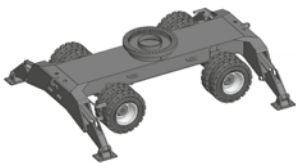

Standard-underridge

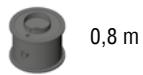

0,8 m

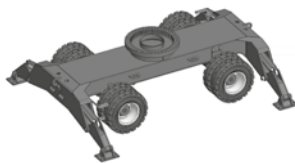

Standard-underridge



1,4 m

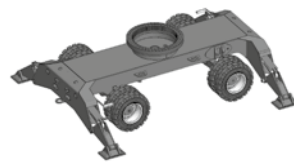

XL-underridge

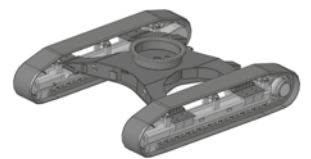

Crawler

CAB SYSTEMS

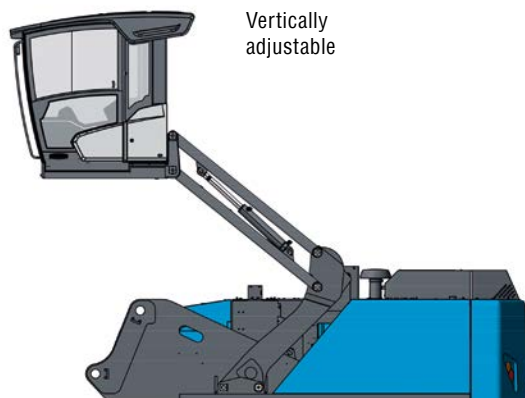

Vertically adjustable

ENGINES

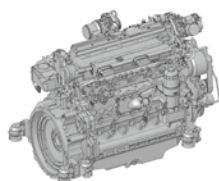

Diesel engine

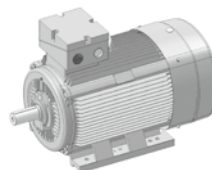

Electric motor

OPTIONS

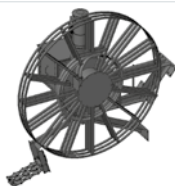

Cable reel

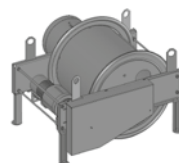

Cable drum

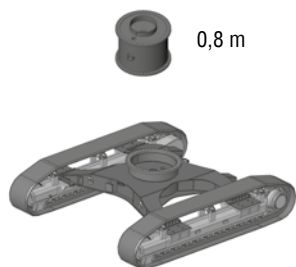

0,8 m

Crawler

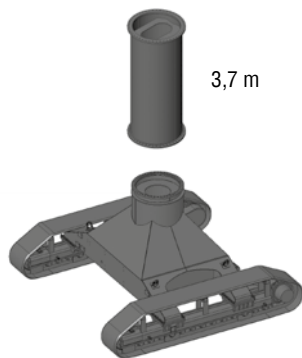

3,7 m

Crawler: XL-undercarriage

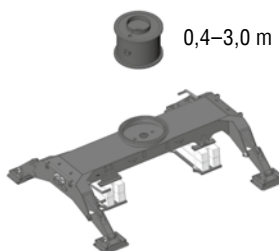

0,4-3,0 m

AHL Standard-undercarriage



0,6-3,0 m

AHL Pylon



FUCHS[®]

A TEREX BRAND

WORKS FOR YOU.[™]

www.terex-fuchs.com

October 2019. Product specifications and prices are subject to change without notice or obligation. The photographs and/or drawings in this document are for illustrative purposes only. Refer to the appropriate Operator's Manual for instructions on the proper use of this equipment. Failure to follow the appropriate Operator's Manual when using our equipment or to otherwise act irresponsibly may result in serious injury or death. The only warranty applicable to our equipment is the standard written warranty applicable to the particular product and sale and Terex makes no other warranty, express or implied. © Terex Corporation 2019 - Terex, the Terex Crown design, Fuchs and Works For You are trademarks of Terex Corporation or its subsidiaries.

Terex[®] Deutschland GmbH | Industriestraße 3 | 76669 Bad Schönborn | Germany | Fon: +49 (0) 7253 84-0 | Fax: +49 (0) 7253 84-102 | info@terex-fuchs.com

